





AC380V



GF630N01系列变频器

断路器

熔断器

接触器

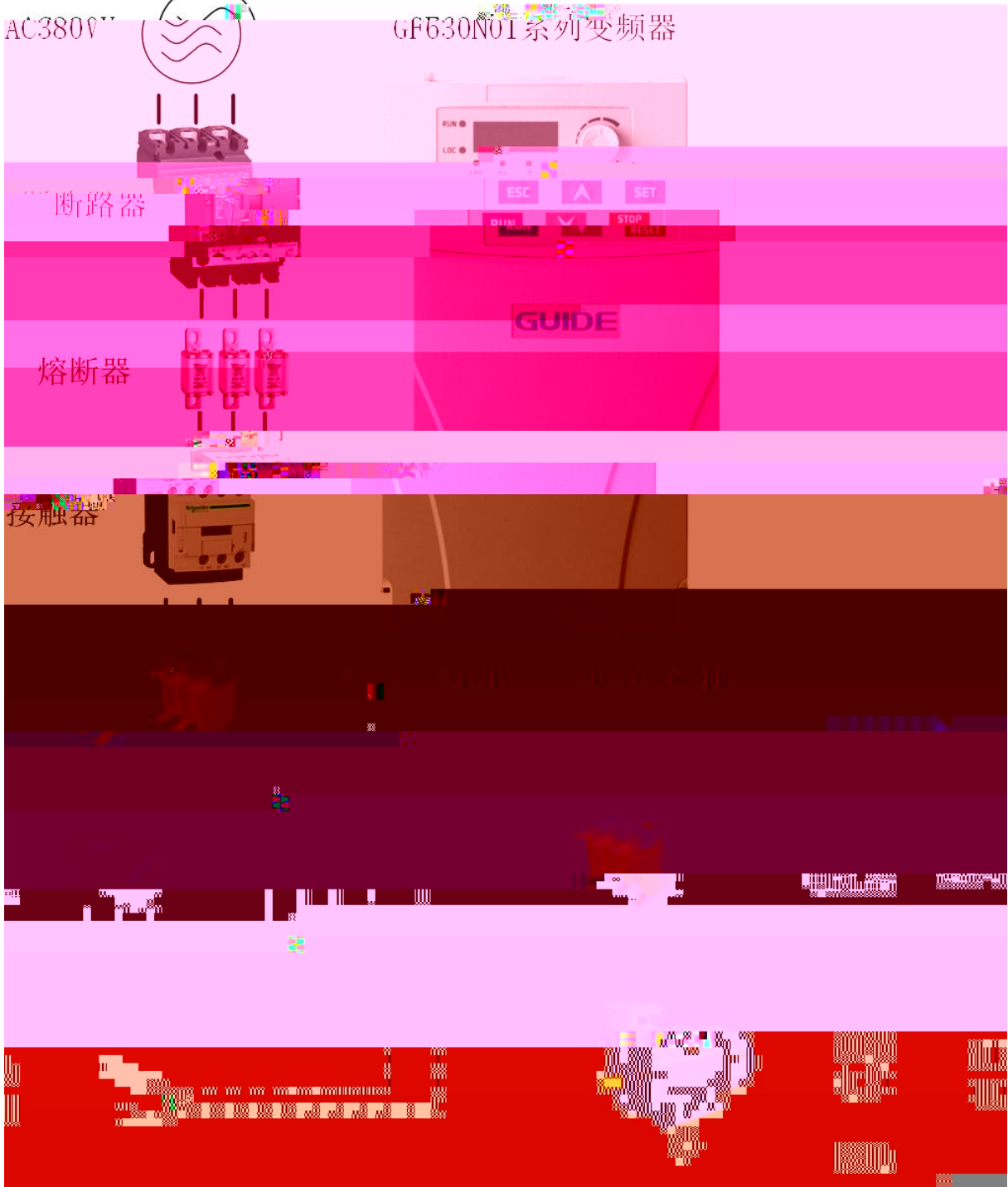







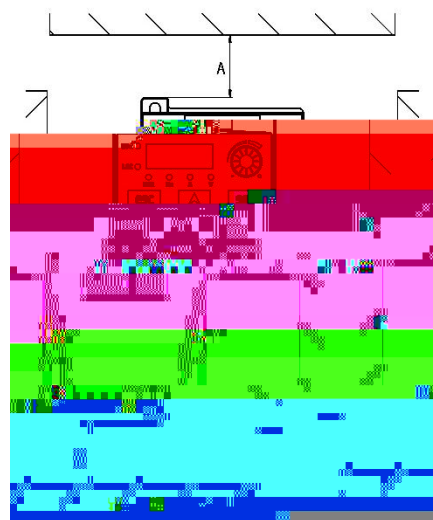
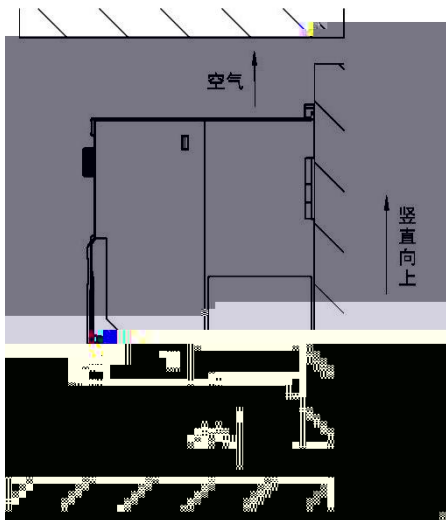
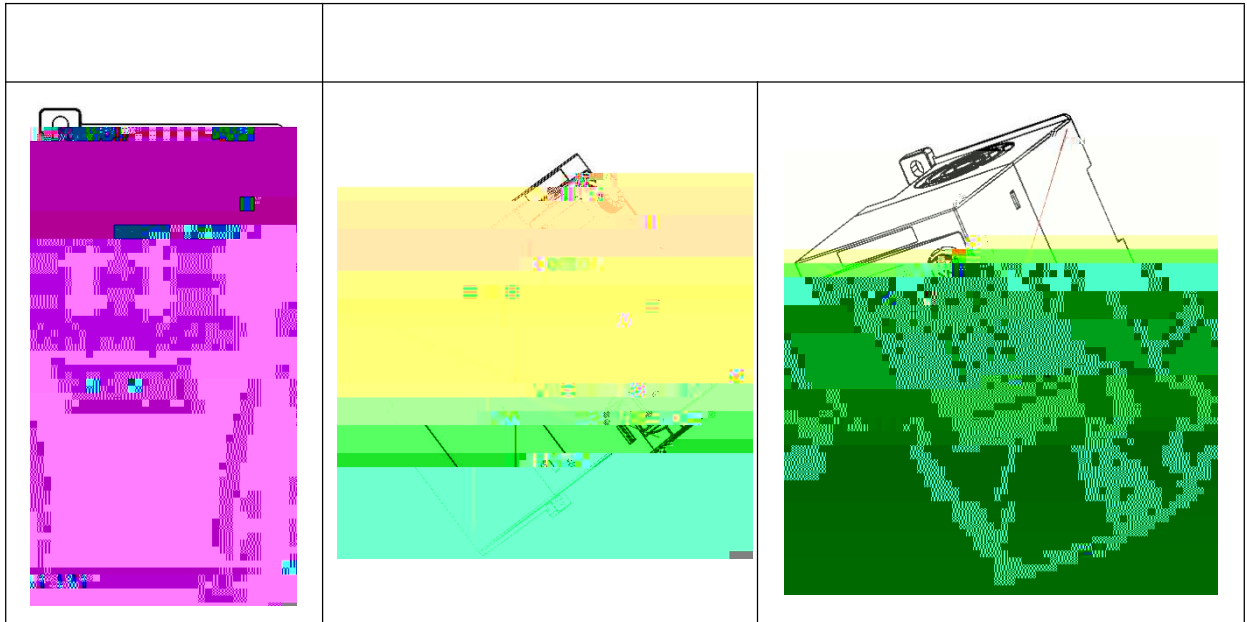



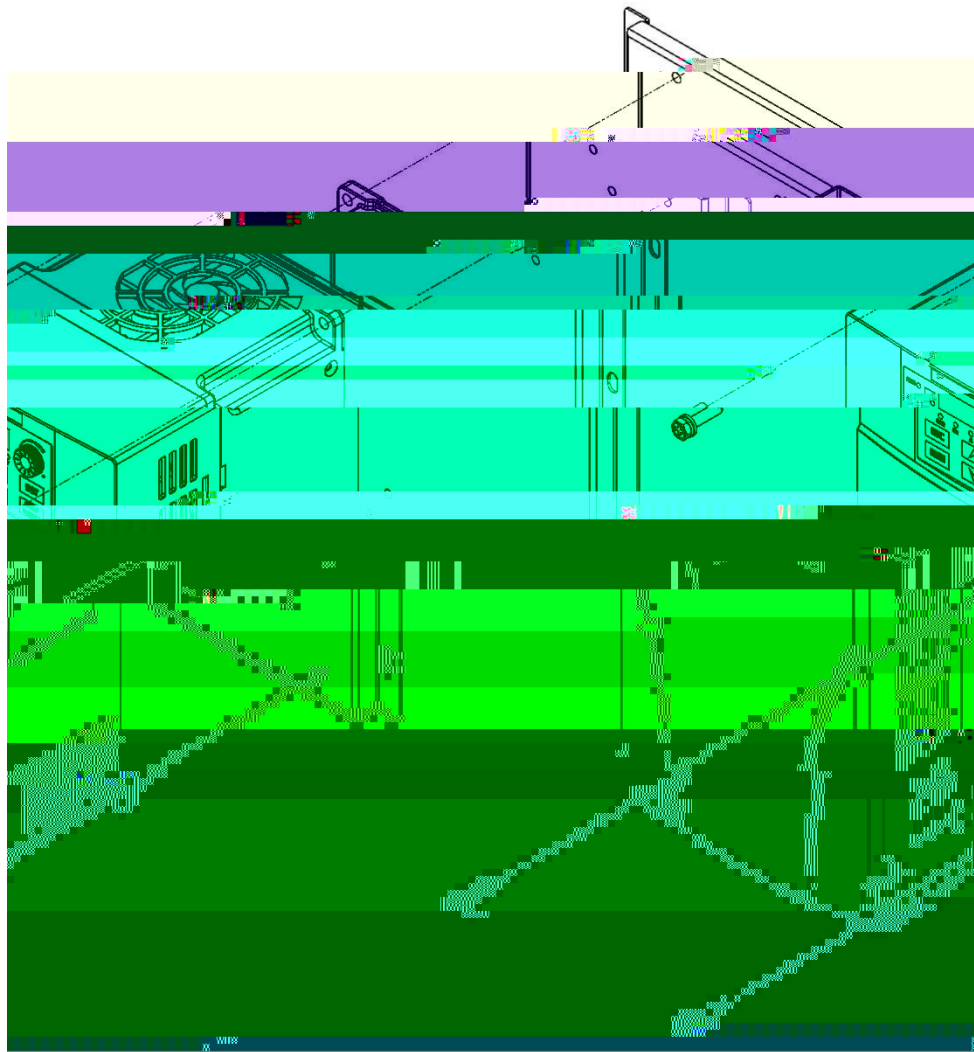

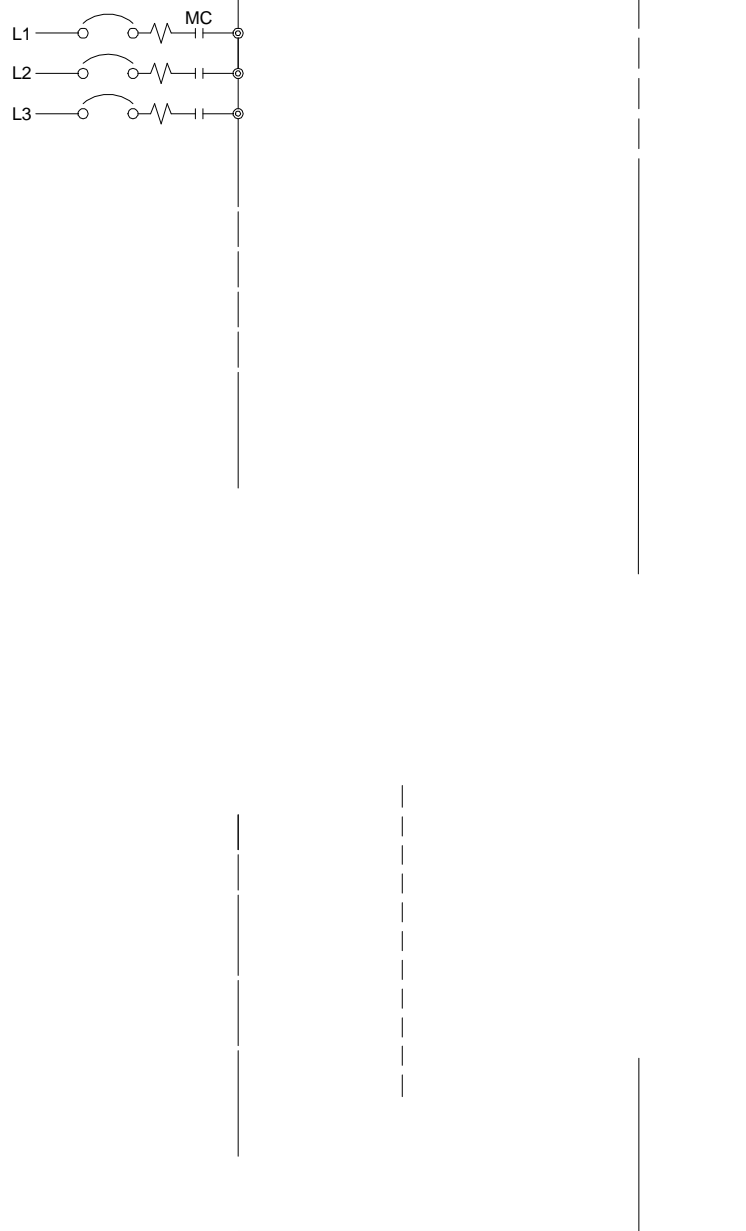

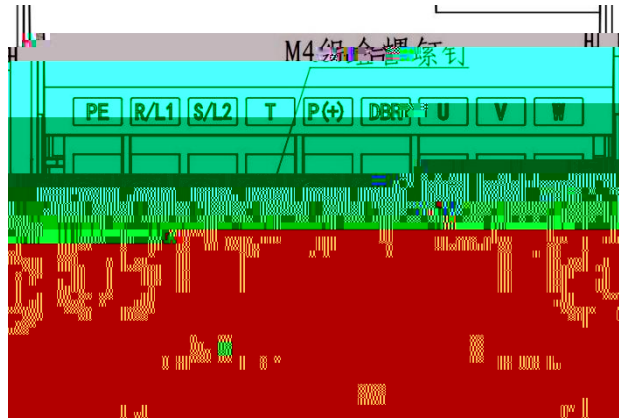
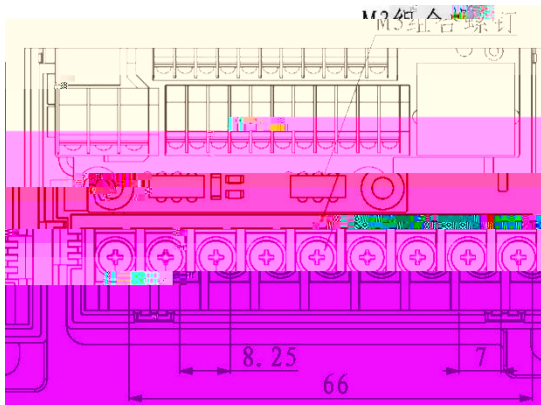

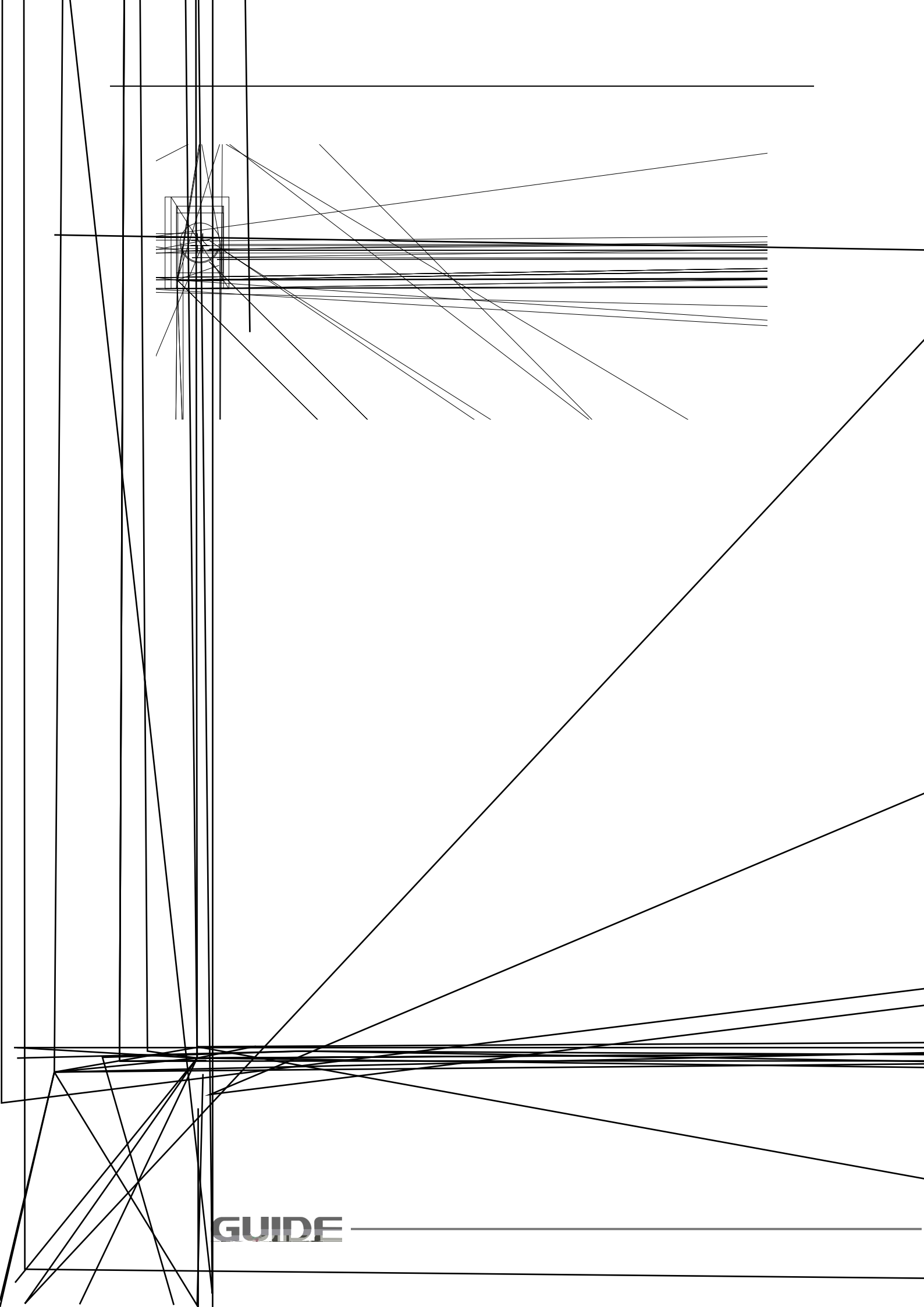

GUIDE —————

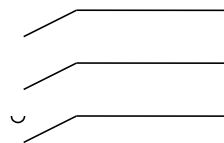

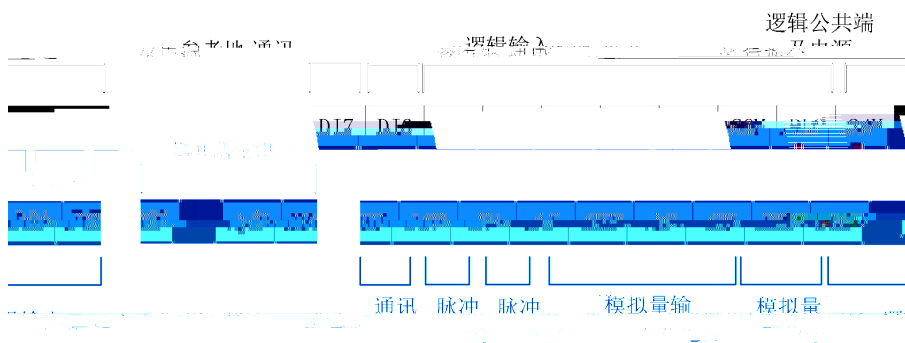
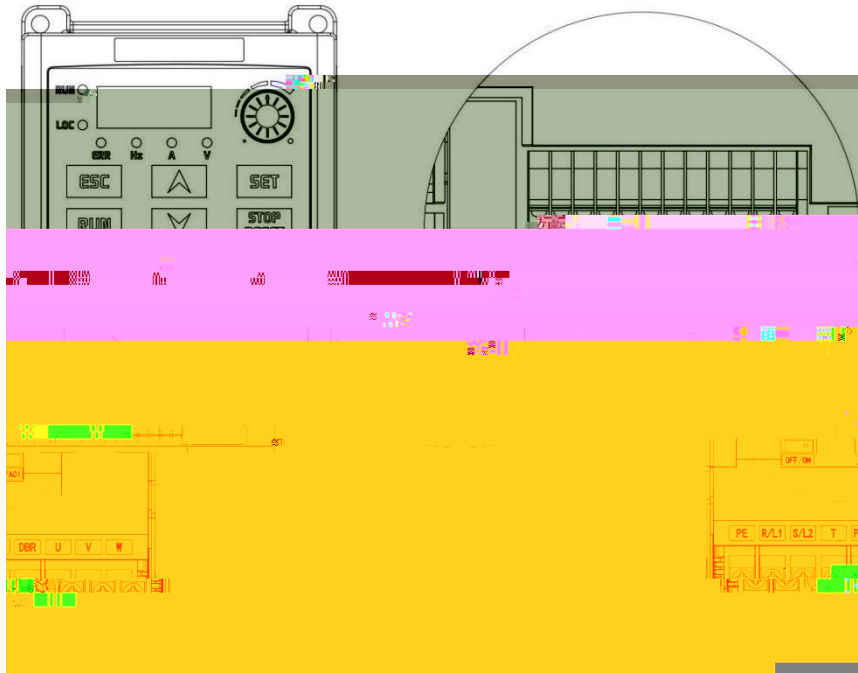



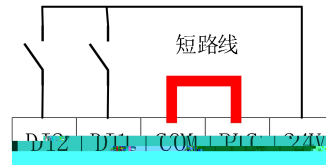
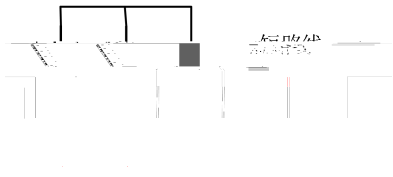
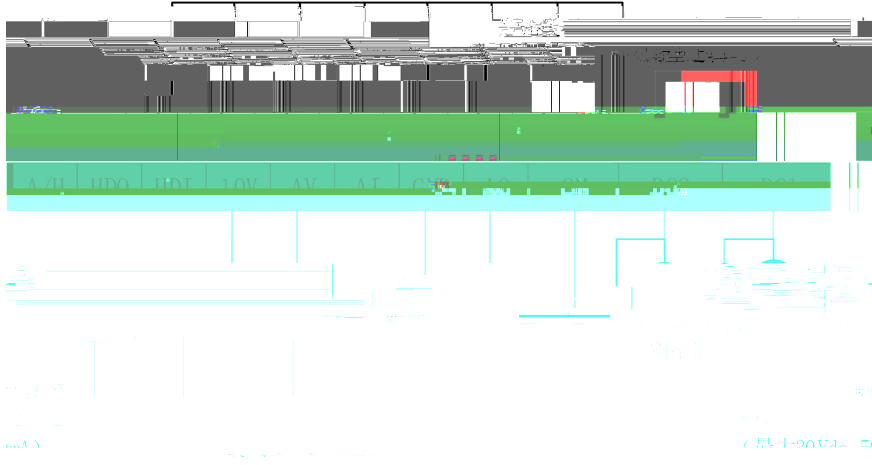

终端电阻



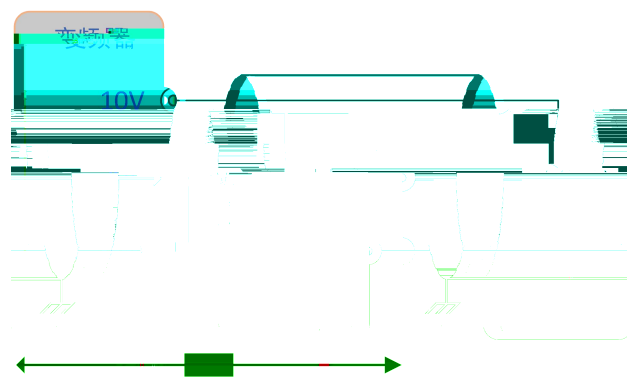
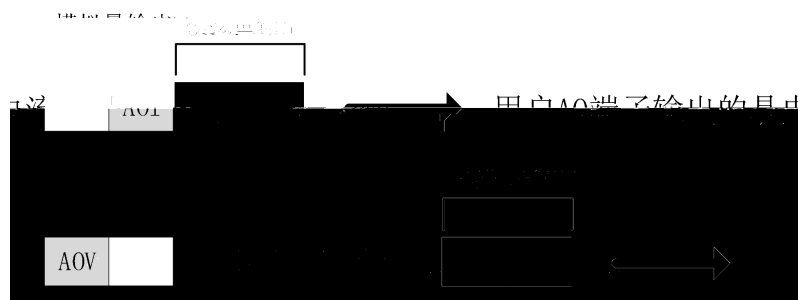

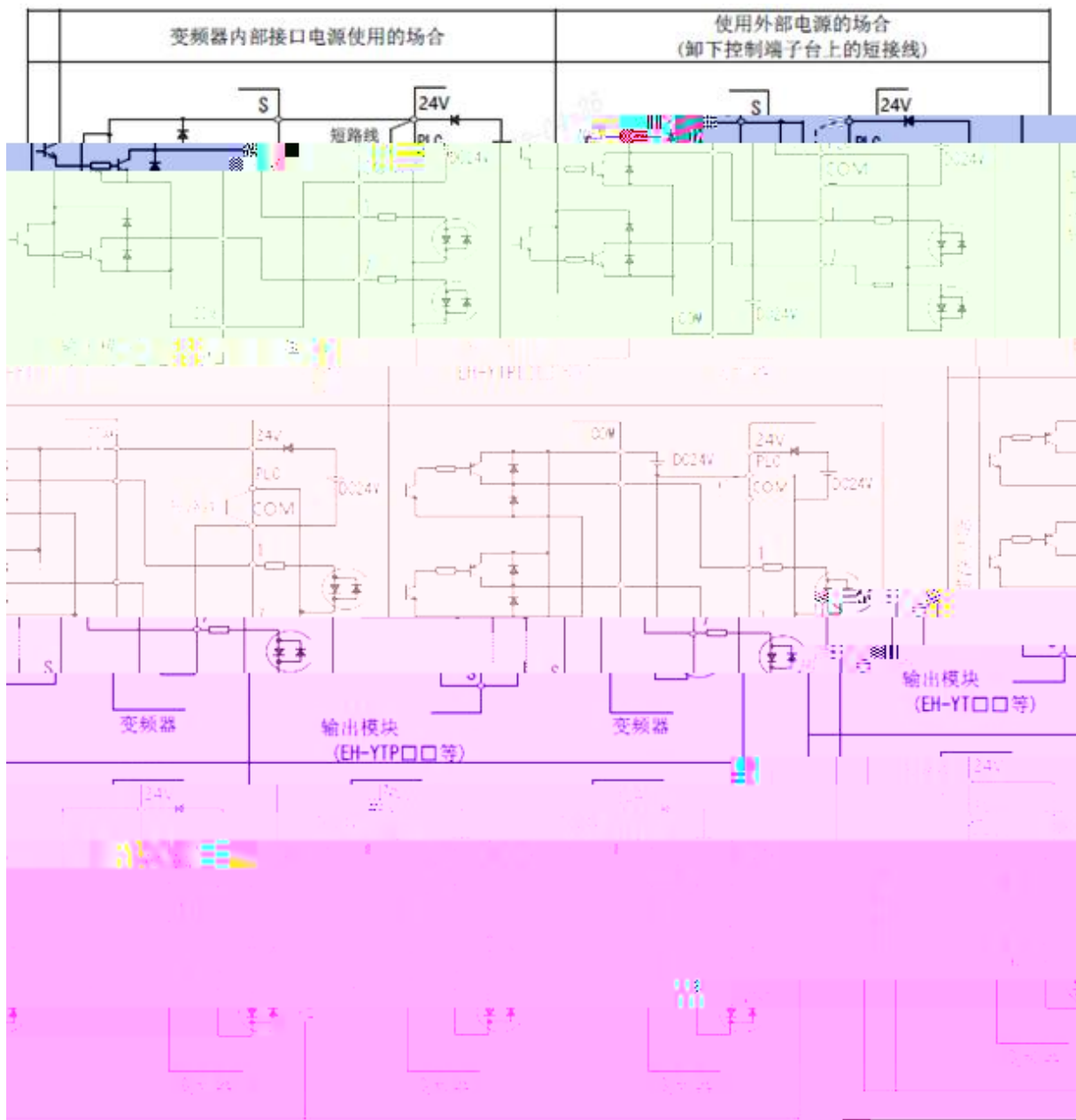
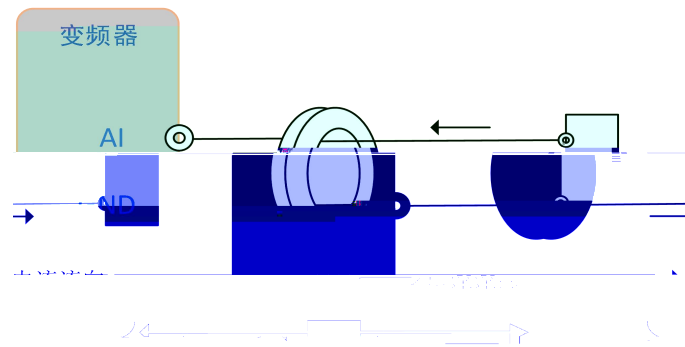

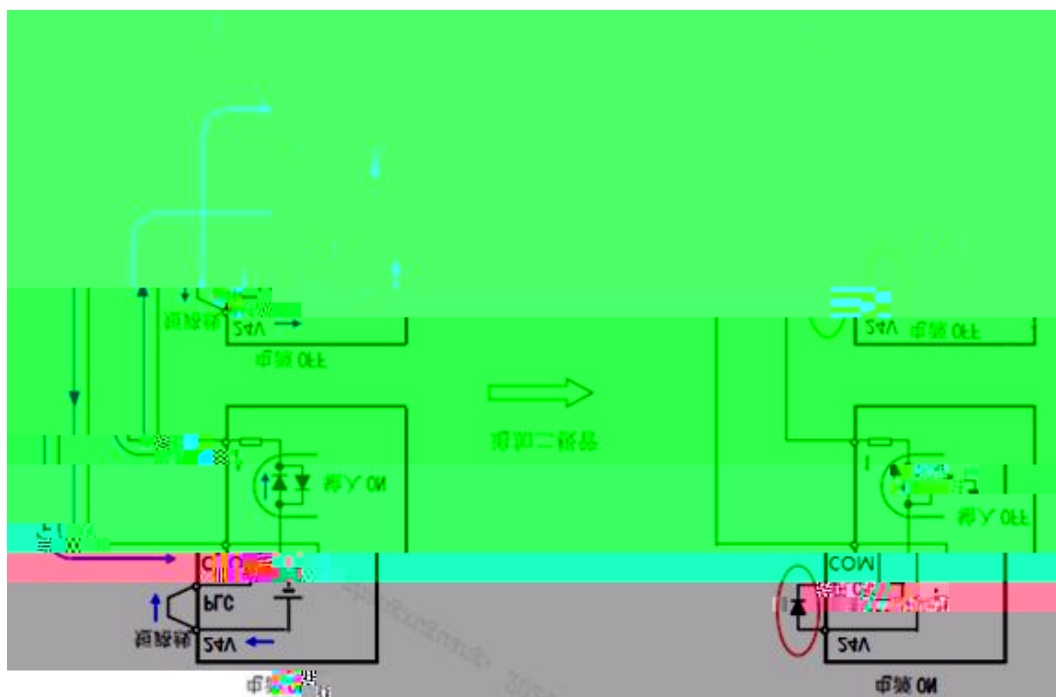

Q Q V C C V

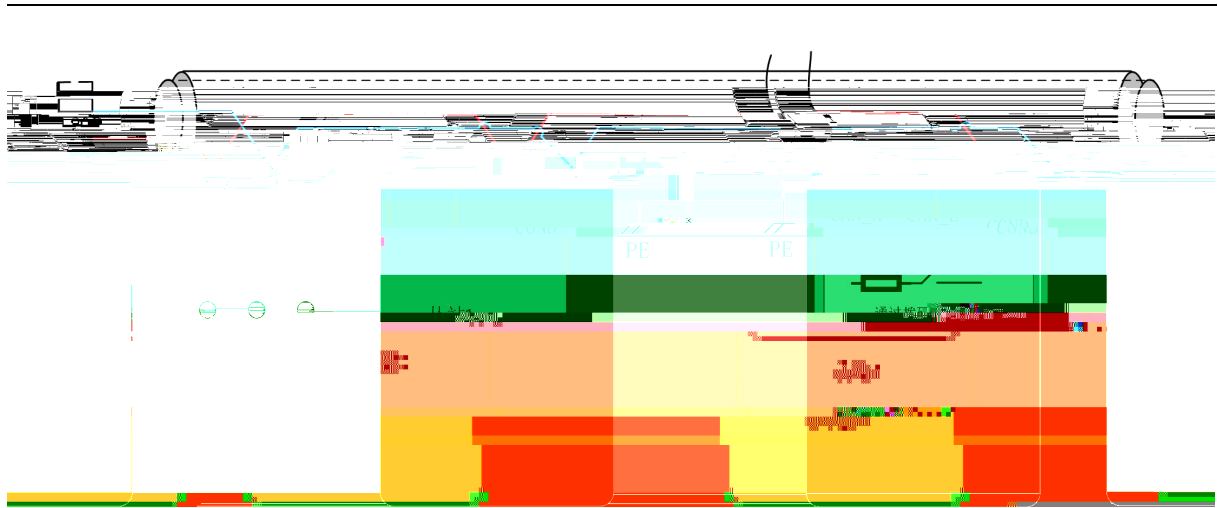

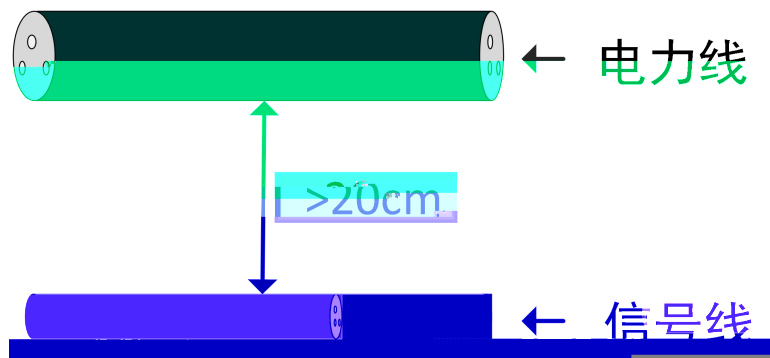

IO

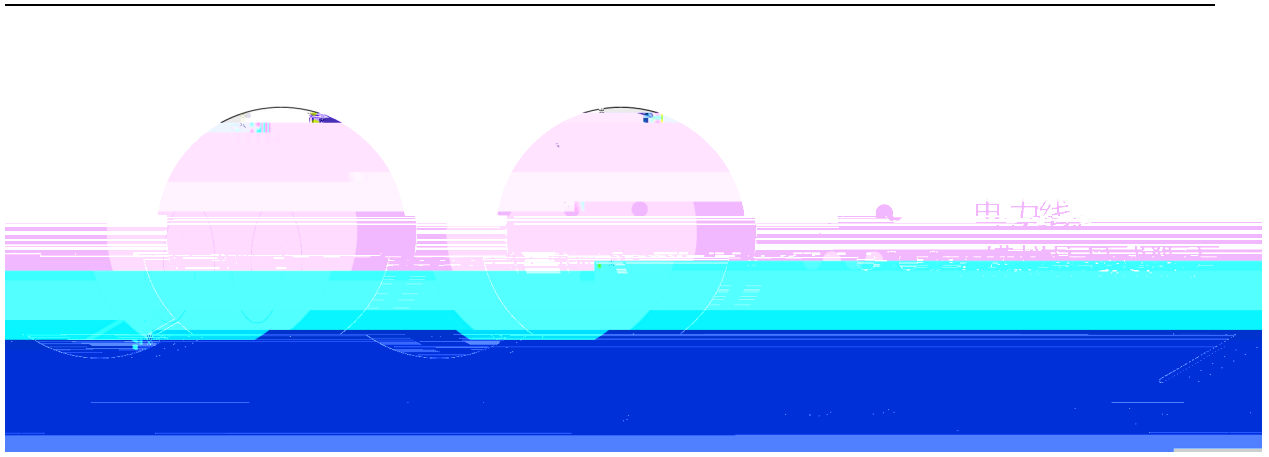

数据显示区





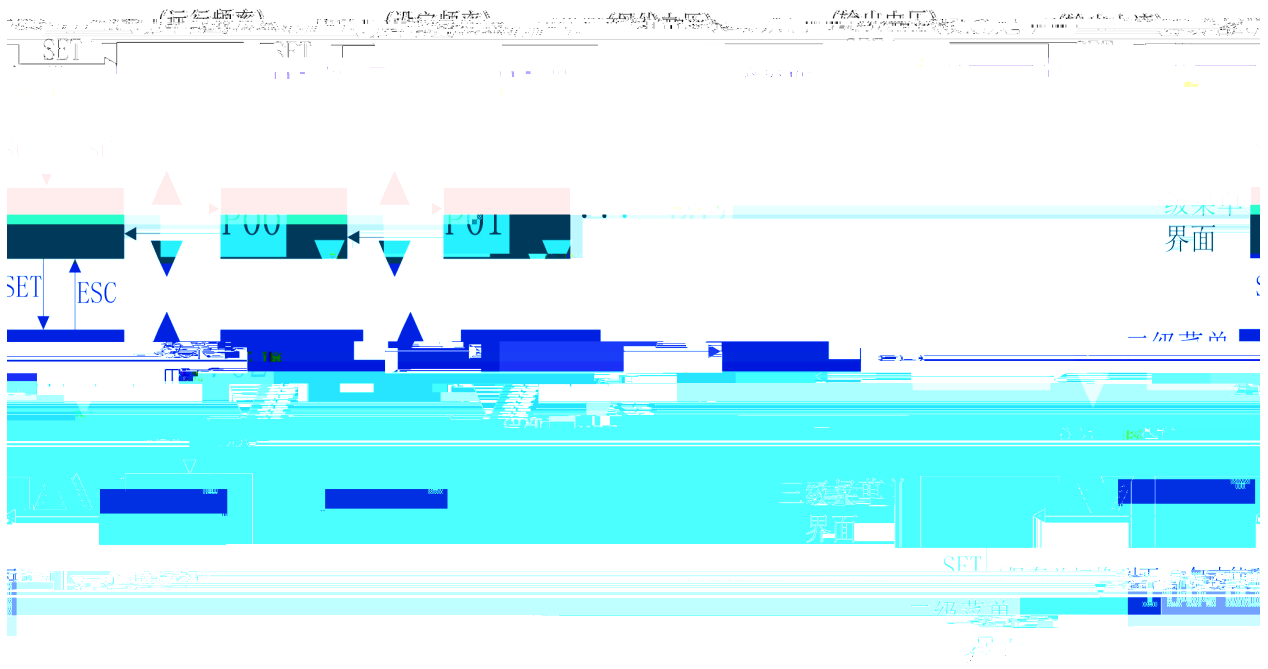

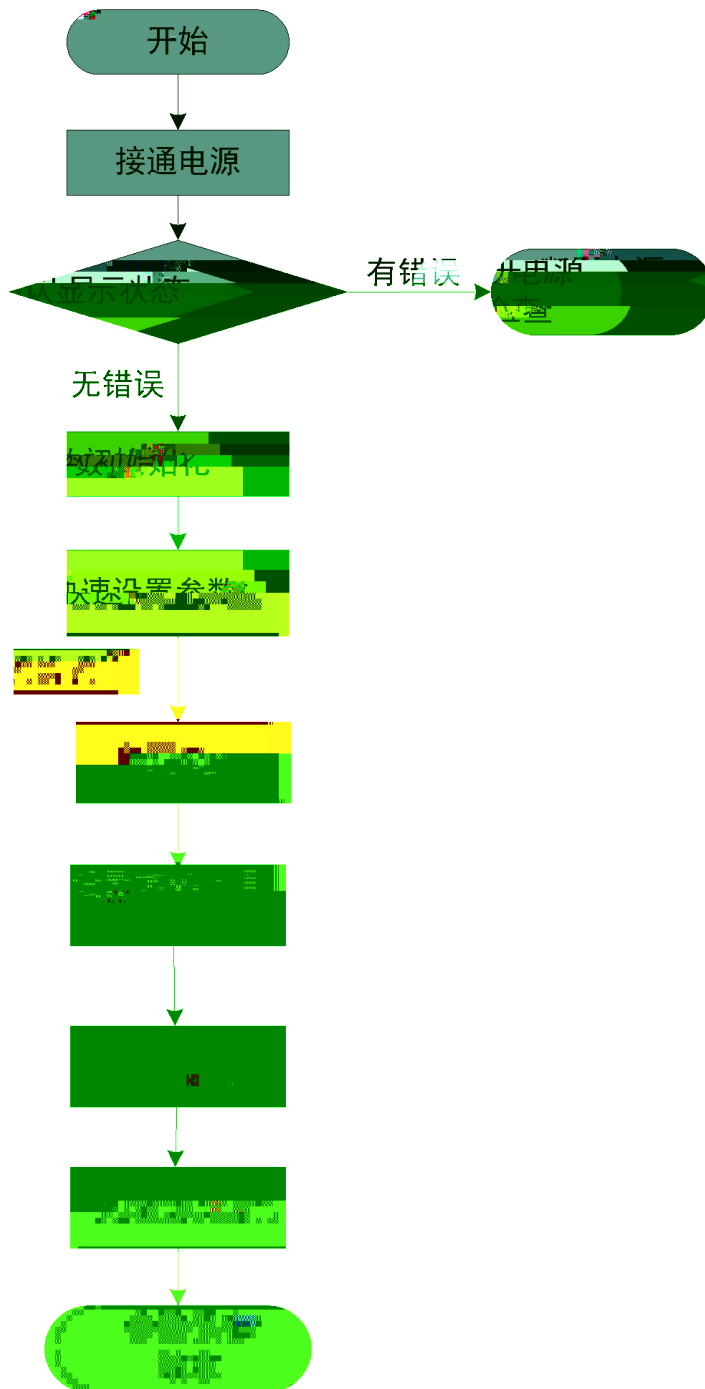

ON

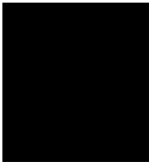



ö 7

j \ 7 0 ~









!f7å

















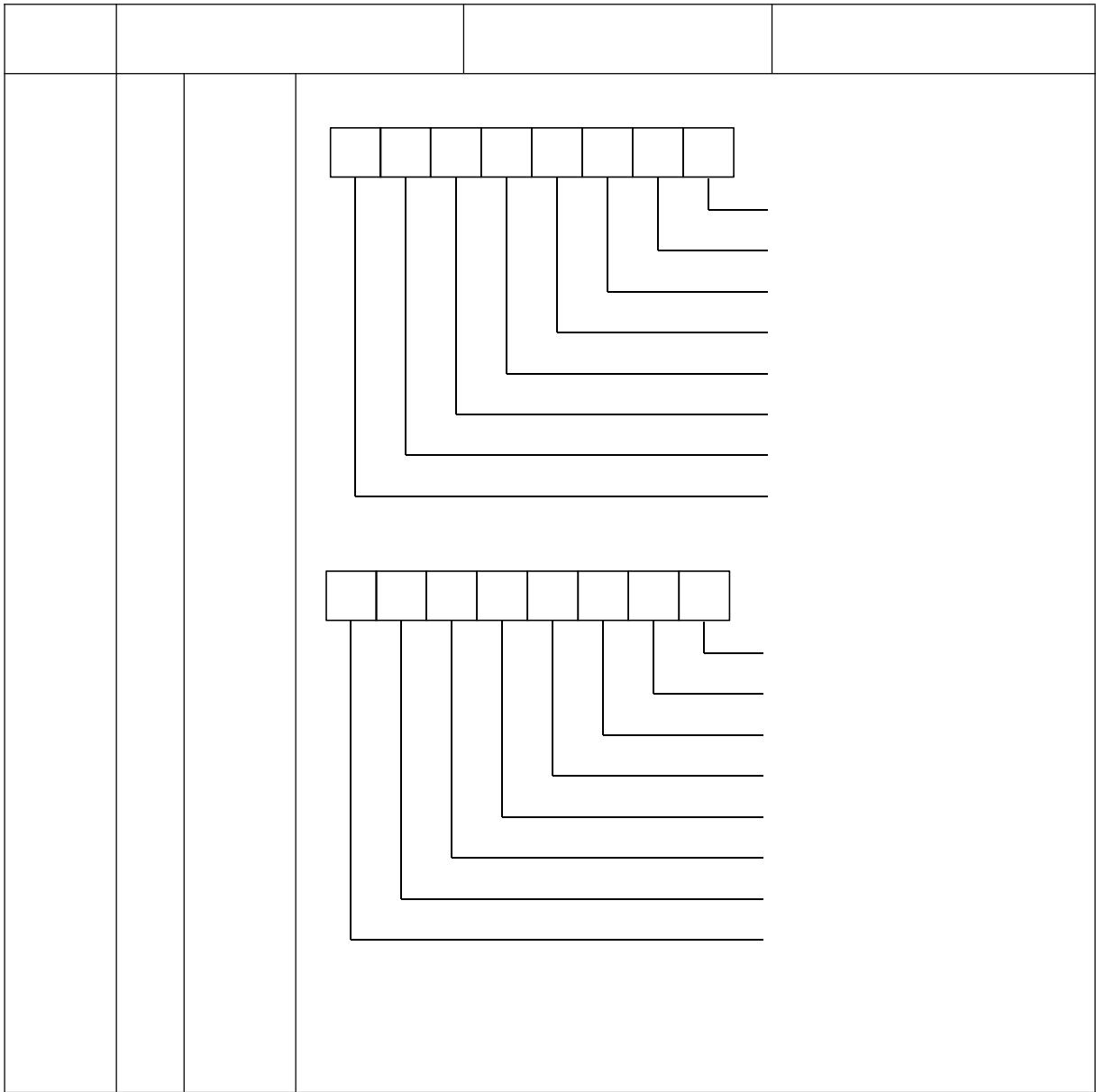













GUIDE

--	--	--	--

21

D u12

E4E- 0

E4E





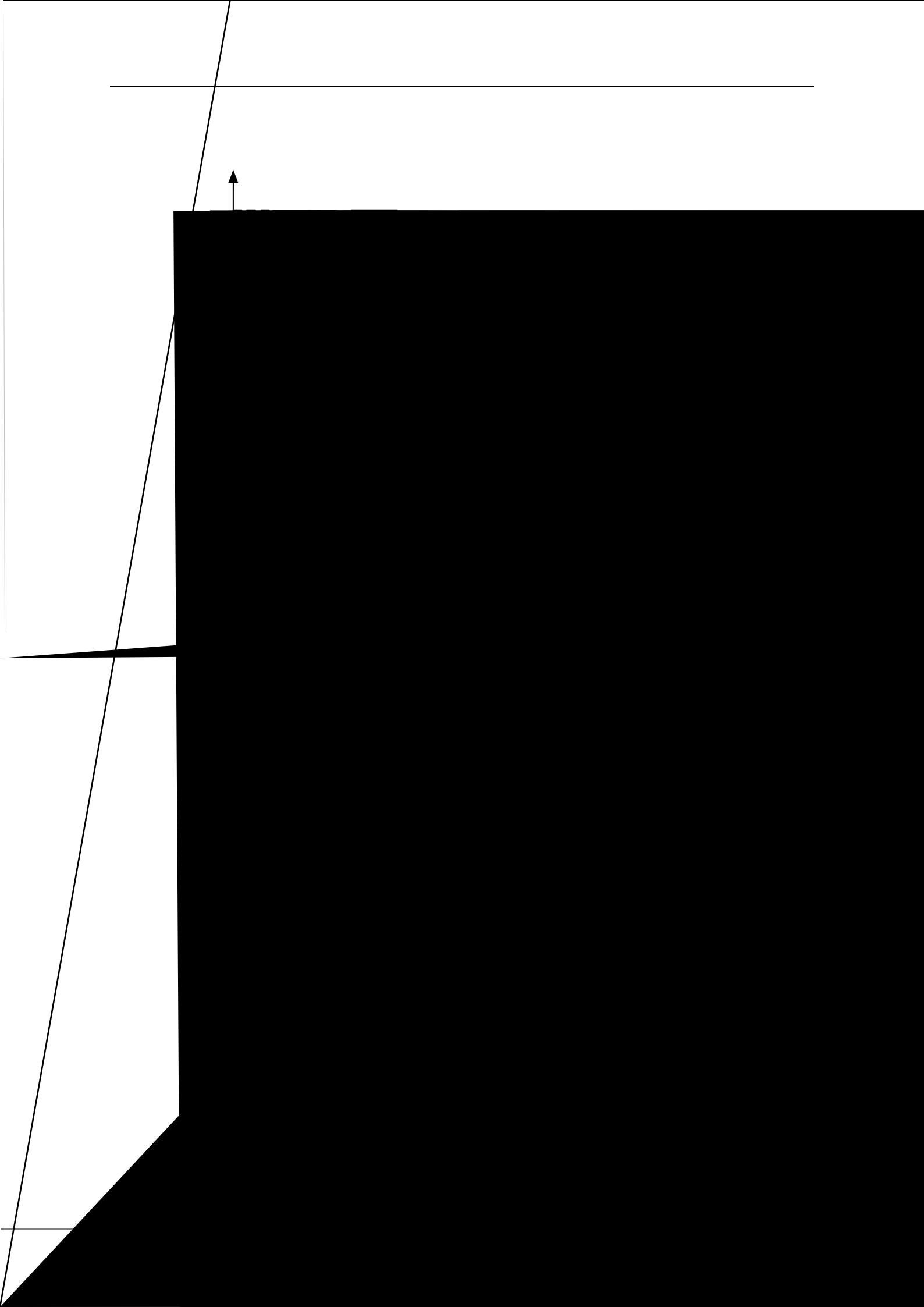





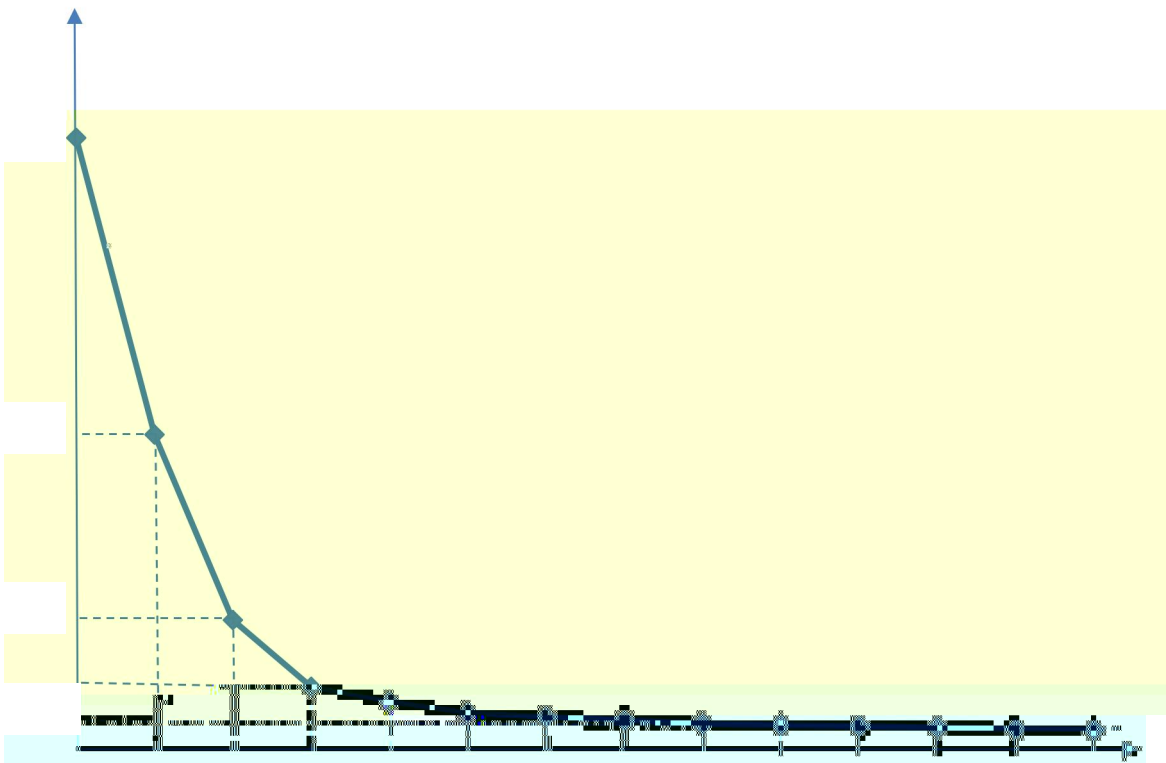



输出电流 ▲

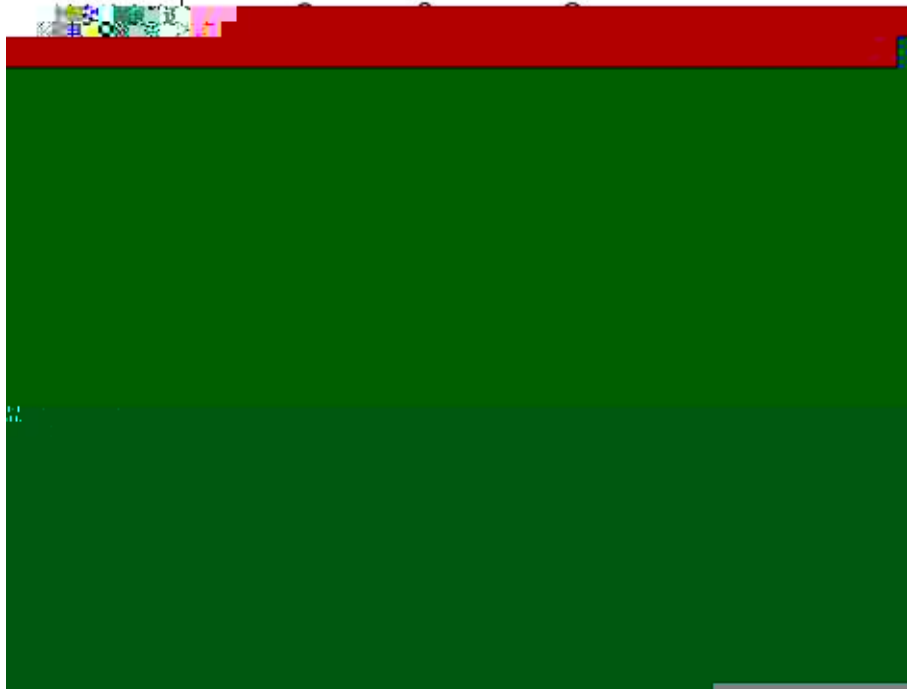

8 Ø			

2

		+e_C\$	

2B
GUIDE





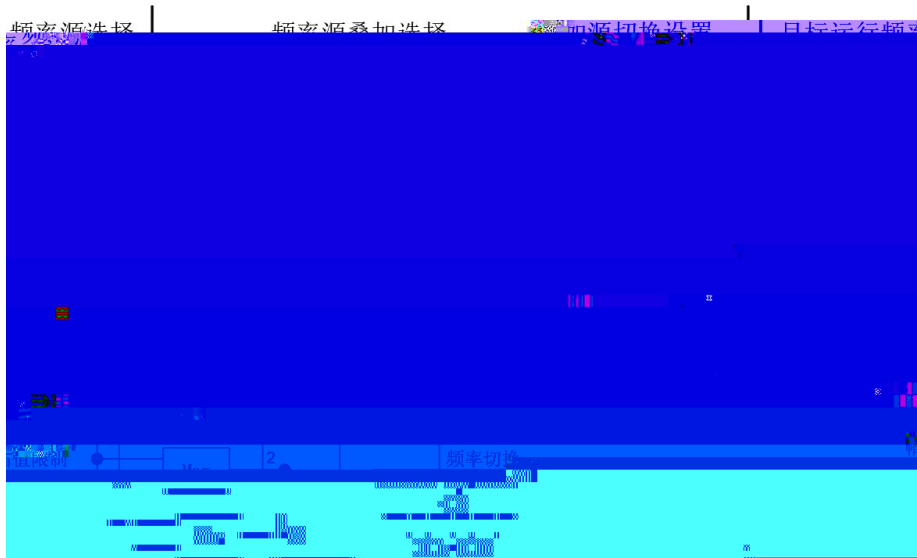

--	--	--	--

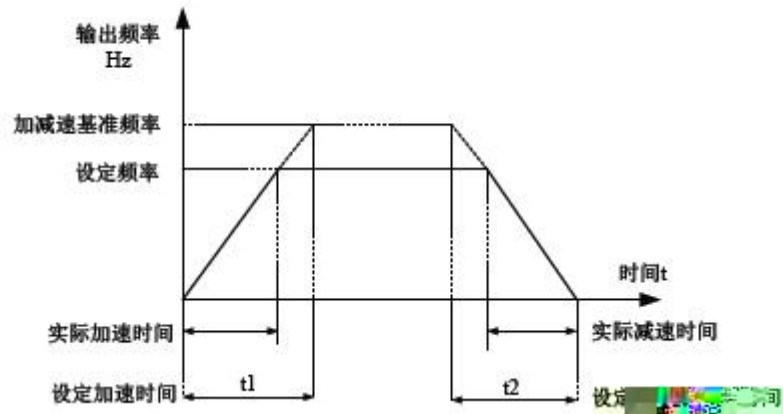



00RFES

$$t = \left(\frac{4}{9} \times \left(\frac{f}{f_b} \right)^2 + \frac{1}{9} \right) \times T$$

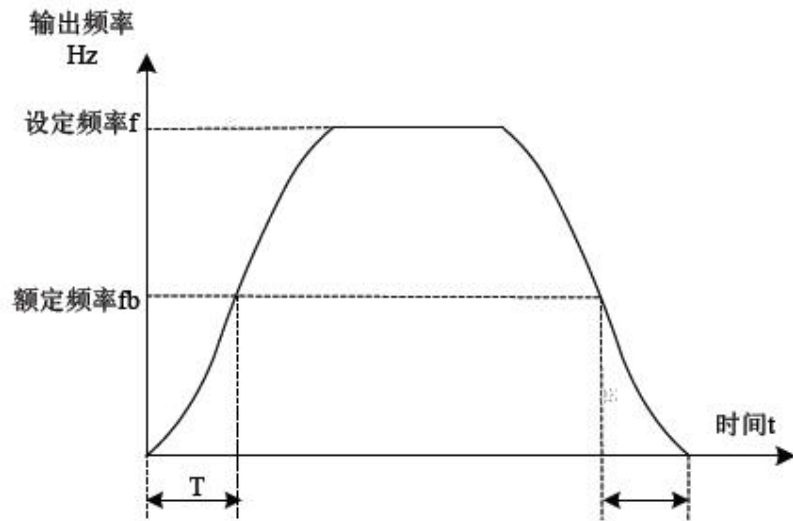



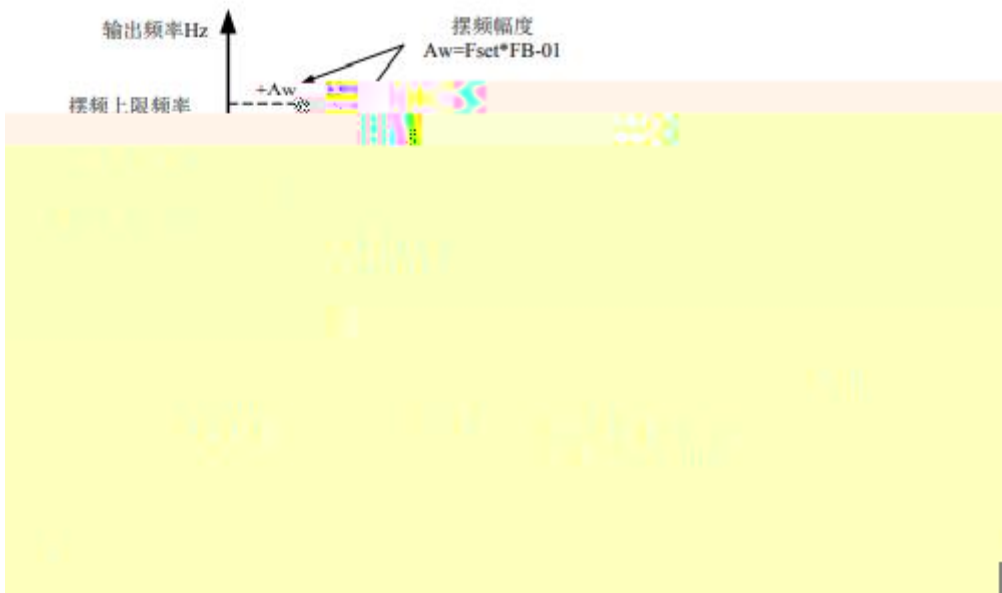

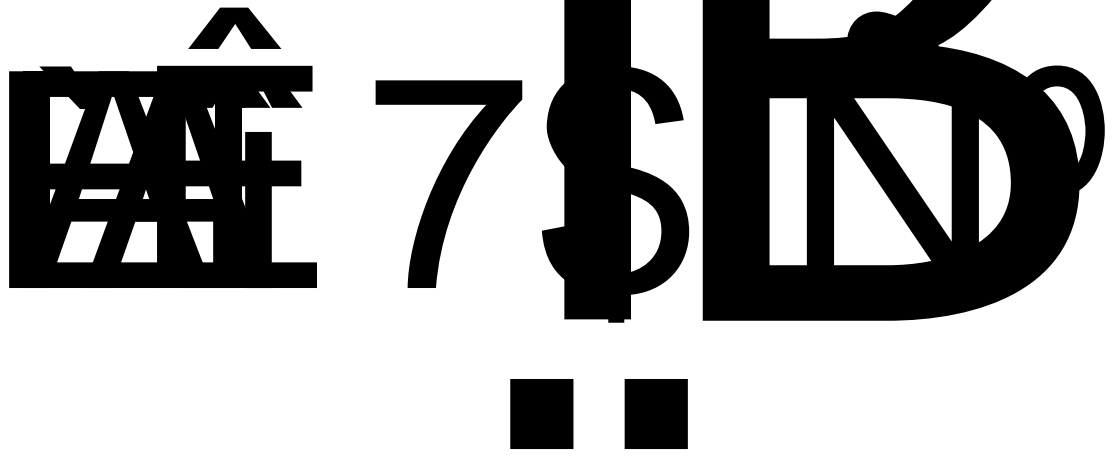

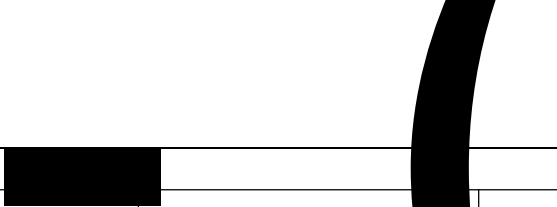



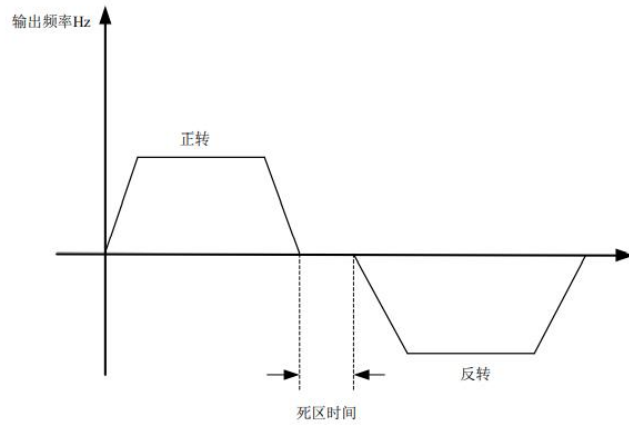



GUIDE

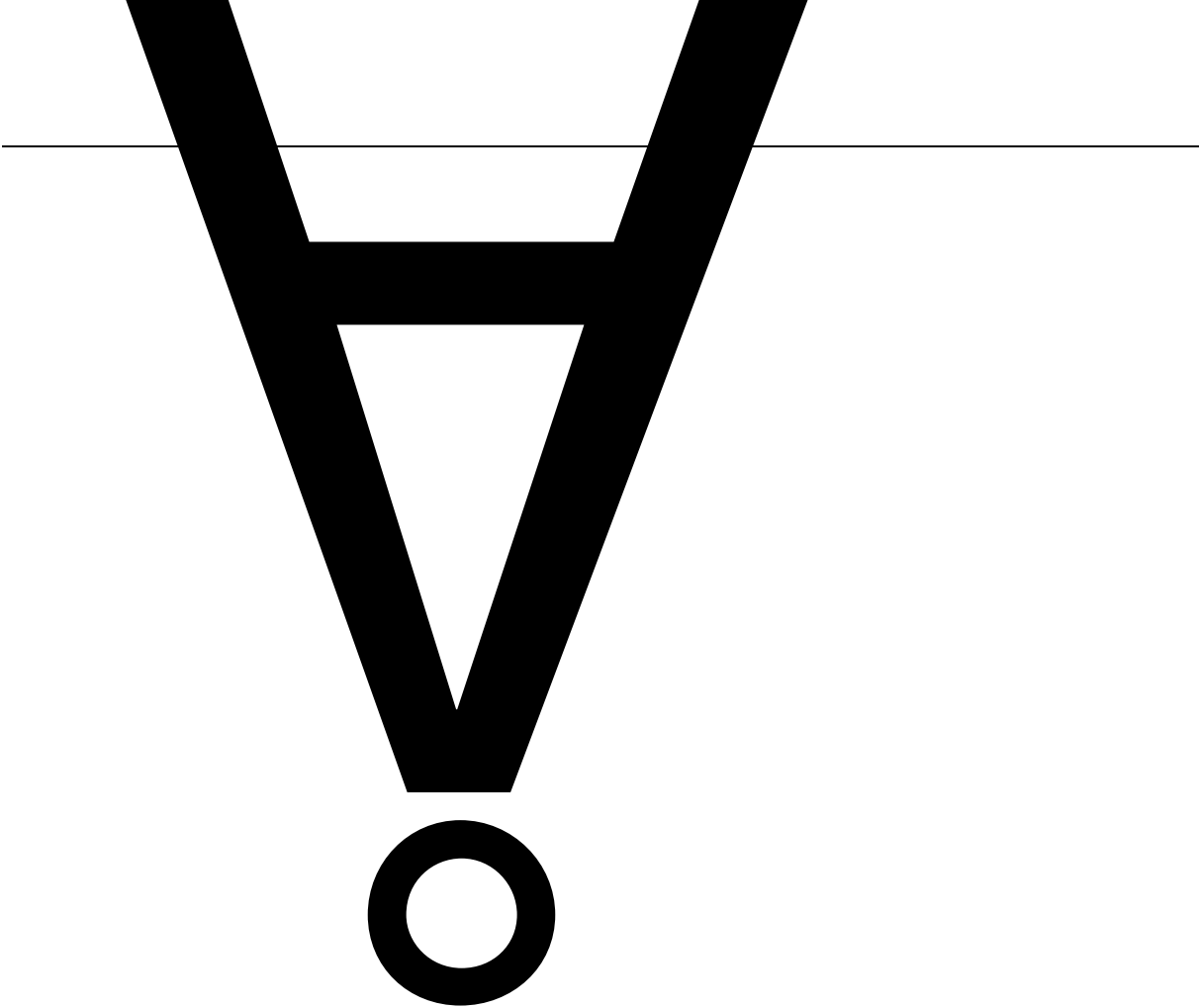

• • • • •

* ^A•é l





8.8.8.8		



Blank space for text or notes.



Blank space for text or notes.





