





∴ \*' \$B\$%  
∴ \*' \$B\$%  
AcXVi g(, )





%

&

,

(

)

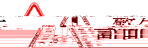

%\$



I J K



ž



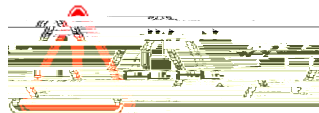
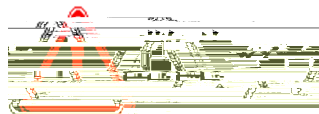
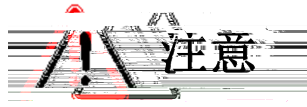



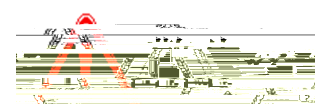
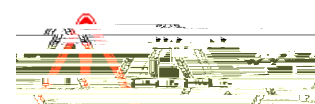

½ Ÿ P

I F5Ž N

%

F78

F7A

F78

F7A

6

F78

F78

F78

F78

&

)\$\$J

)A»

,

%

*" %	D&\$		
*" %		D&%	
*" &\$	D&'		
*" &%	'	D&,	
*" &&	(	D&-	
*" &'	'		D' \$
*" &(	'		D' %
+			
+" %	D\$		
+" &	D&		
+" '		D'	
+" (		D(	
+" )			D)
+" *			D*
+" +	D+		
+" ,		D,	
+" -	D-		
+" %\$ J#:		%	D%\$
+" %%	D&%		
+" %&	D%&		
,			
," %			
," &			
-			
-" %			
-" &			
-" '			
-" (			
-" )			

%

%%

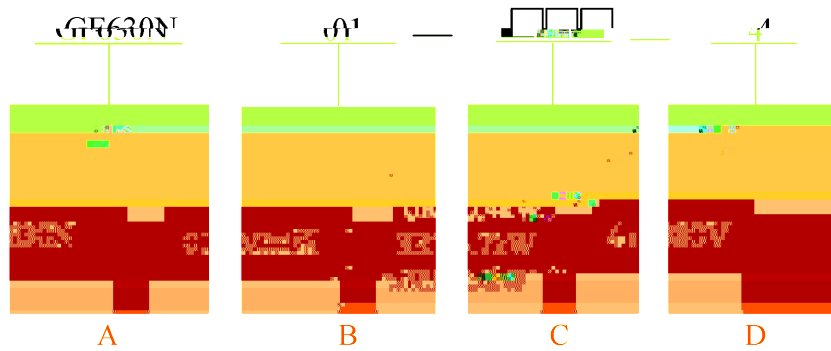

5	;: *' \$B
6	\$% A] b]
7	\$F(. \$" (_K ' F+. '" +_K )F.)")_K
8	(. ', \$J

;: \*' \$B\$%

\$" (\_K

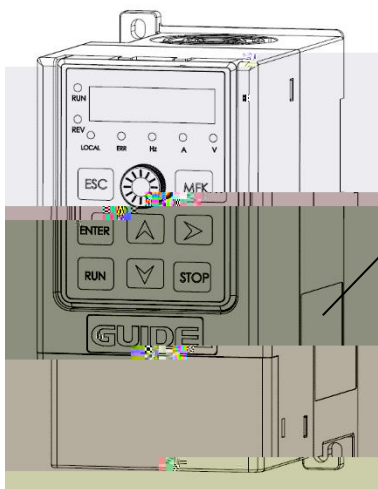

型号: GF630N01-0R4-4  
额定功率: 0.4kW 变频器  
额定电压: 10A

76011Z 输入: AC3PH 380V-480V 50  
240V 11.500HZ 输出: 1000W 10A 3PH

STAND: V1.00 Product ID: Product ID: E-3  
DEIN CHINA 8888888A8A088 MAI

有限公司 制造商: 武汉港油技术股份



% &

;: \*' \$B\$%

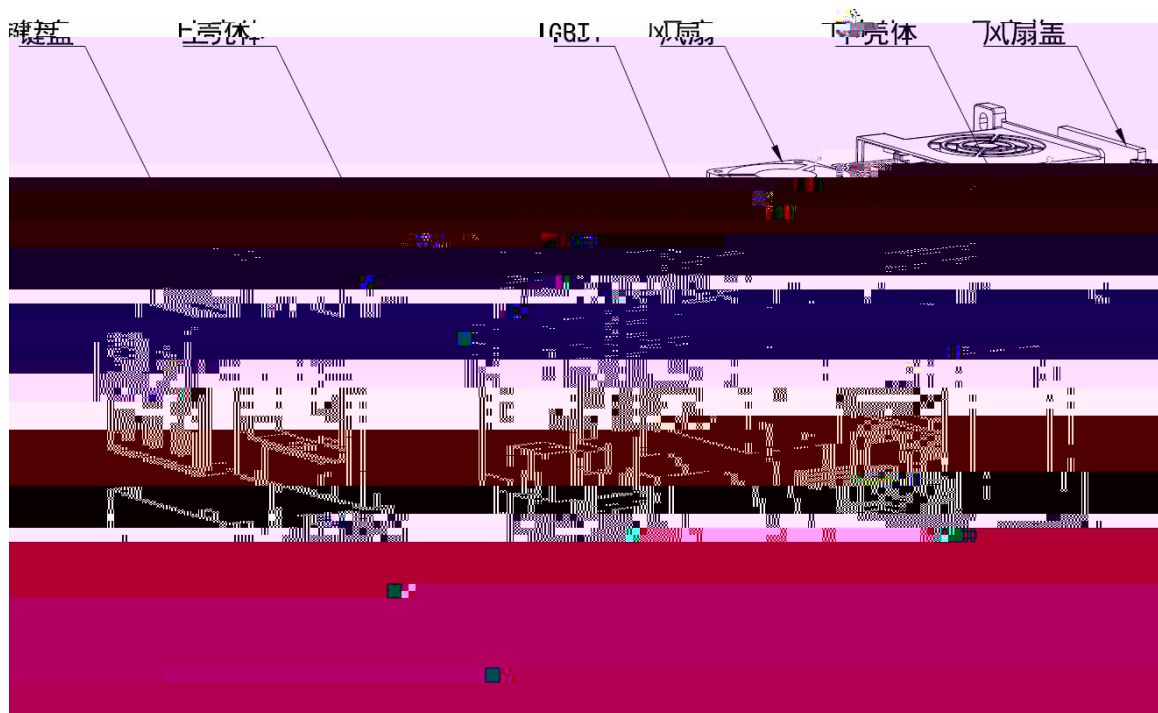

F%

', \$J (, \$J \$"(\_K &"&K



F&

', \$J (, \$J "'+\_K )" )\_K

% ' F% F&



F%

\$" (\_K &" &\_K



F&

' "+\_K )" )\_K

\*

**GUIDE**

kkk" [XYhYWWta





---

% \*

(1)

(2)

% \$i

(3)

% +

---

	Q_KQ	Q_KQ
:: *' \$B\$% \$F! (	\$" (	\$" \$&*
:: *' \$B\$% \$F+! (	\$" +)	\$" \$' '
:: *' \$B\$% %F% (	% %	\$" \$' )
:: *' \$B\$% %F)! (	%)	\$" \$( \$
:: *' \$B\$% &F& (	&" &	\$" \$( ,
:: *' \$B\$% ' F+! (	' " +	\$" % &
:: *' \$B\$% )F)! (	)"	\$" %* \$



&

&" %

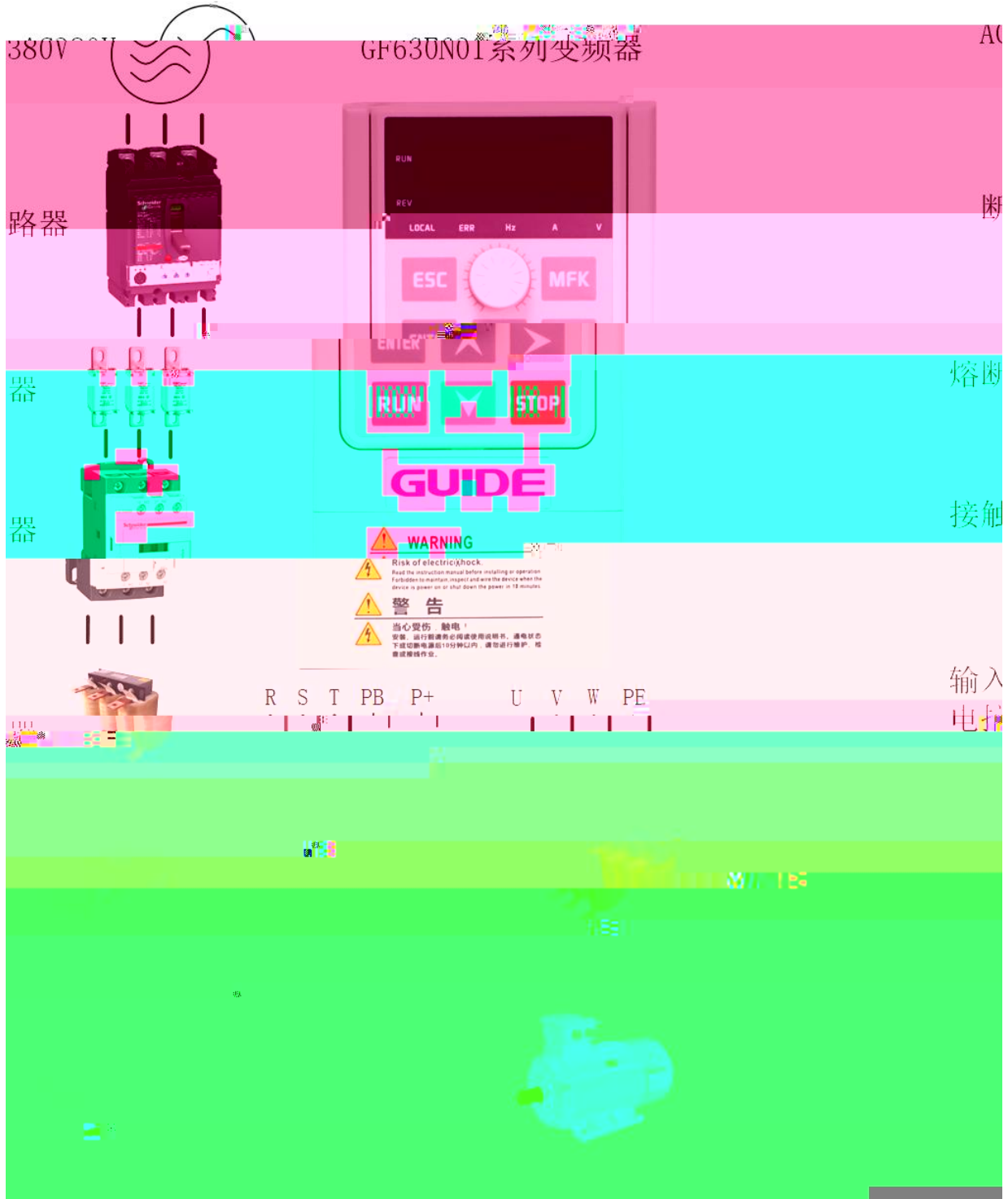

:: \*' \$B\$%

kkk" [ XYhYVWVta

**GUIDE**

%/



&"'

	5	# aa*	5
	79. F	(\$i	f157! ' 7
\$" ( _K	% &	&")	-
\$" +) _K	&")	&")	-
% %_K	'	&")	-
%) _K	' " +	&")	-
&" & _K	)	&")	-
' " + _K	-	&")	%&
)") _K	%	&")	%&

&" (

	&i		%	
	5	a<	5	a<
\$" ( _K	&" &	*"' +	%,	' " , -
\$" +) _K	' "\$	("*+	&"*	&"*-
% %_K	(" \$	' ")\$	' "'	&"%&
%) _K	(" ,	&" -&	(	% +)
&" & _K	*" ,	&" \$*	)" +	% &&
' " + _K	%&" \$	% %+	%\$" &	\$" *-
)") _K	% " \$	\$" +,	%	\$" (+

&")

			?K ' \$! ?W	?K )\$! ?W
\$" ( _K	+) \$	%\$\$	\$" &	\$" '
\$" +) _K	+) \$	%\$\$	\$" &	\$" ' )
% % _K	( \$\$	%\$\$	\$" (	\$" )
% ) _K	( \$\$	%\$\$	\$" )	\$" +
&" & _K	&) \$	+,	\$" ,	%
' " + _K	%\$\$	* (	&" \$	&" )
)" ) _K	%\$\$	( \$	&" \$	&" )

%

%\$\$ &

' "%

	<p>%)V#</p>		*
!%\$ Z(\$ (\$ % % )\$  !%\$		!&\$ Z*\$ % #	!&\$ Z*\$
+\$ %\$* _DU \$" + %" \$)	+\$ %\$* _DU \$" + %" \$)	*\$ %\$* _DU \$"* %" \$)	
%\$<n Z )+<n \$" \$+) aa )<n Z %\$<n -", a#g&	%\$<n Z )+<n \$" \$+) aa )<n Z %\$<n -", a#g&	==	
		%%\$a#g^ %/ag	%%\$a#g^ %/ag
		&) \$aa O%%\$_[ %%\$aa %%\$_[	&) \$aa O%%\$_[ %%\$aa %%\$_[
	-)   F<		
	%%\$\$\$	%%\$\$\$	%%\$ %
		' \$\$\$	
	&		

' "&

' "&"%

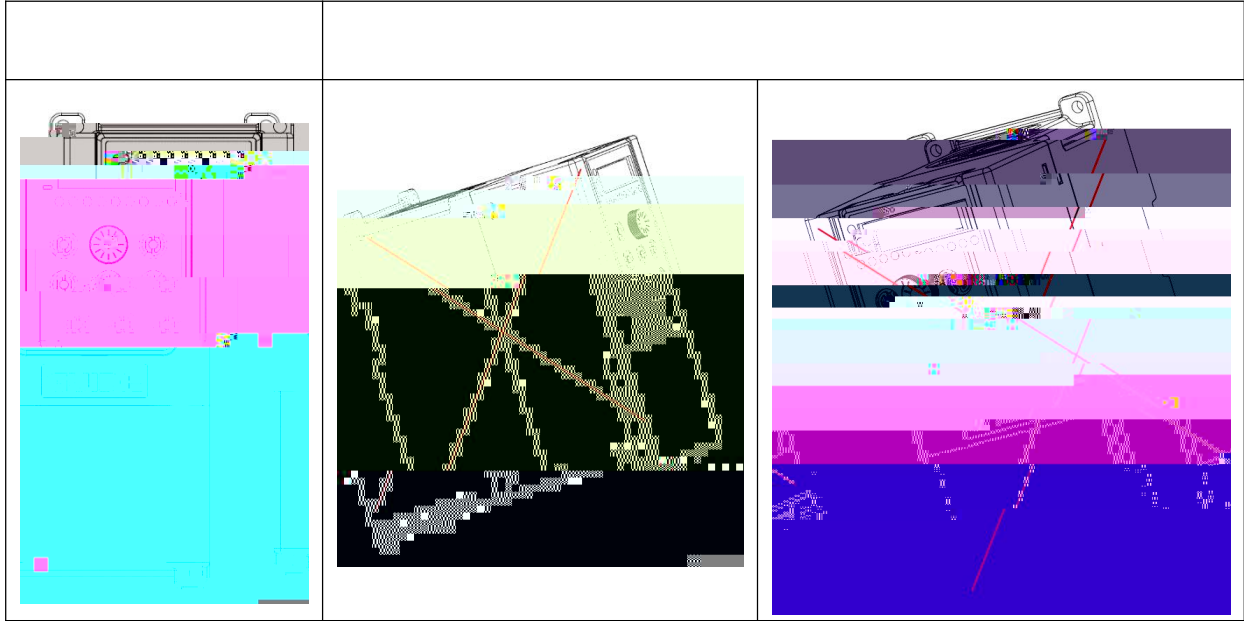

' "&"&

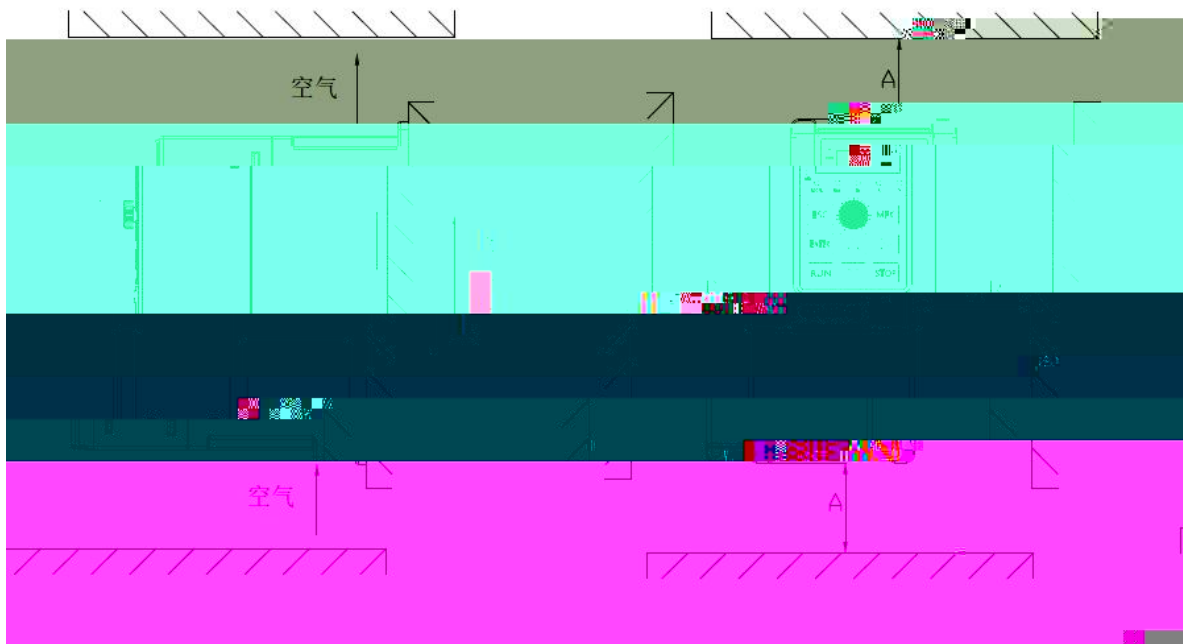

		fl	aat
F%	\$( _K &" &_K	5 %\$\$	6 &\$
F&	' " +_K )" )_K	5 &\$\$	6 &\$

' " &"'

% F%

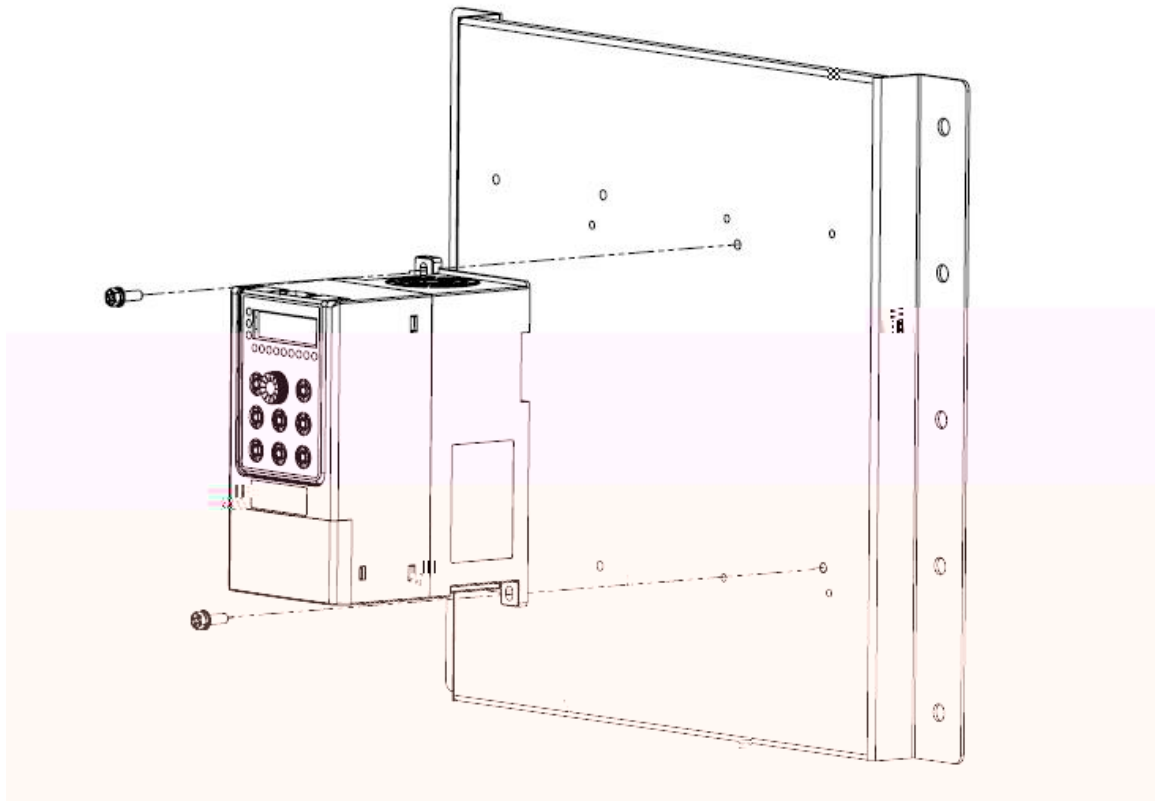

& F&

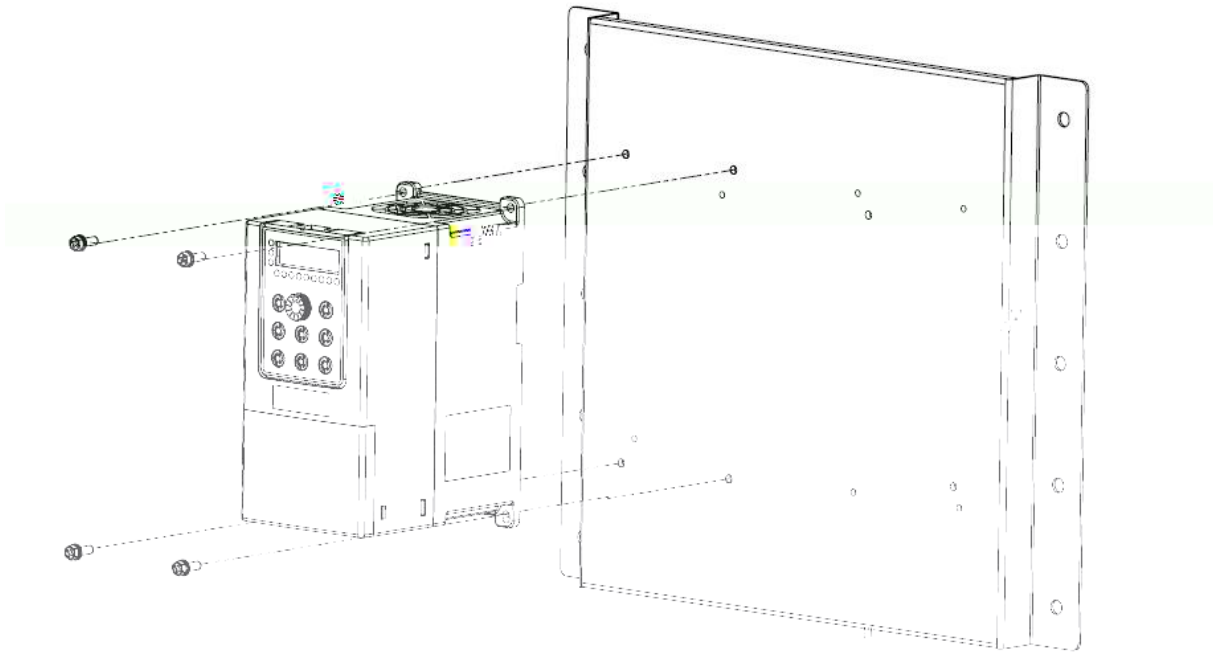

%	F%	\$" (_K &" &_K	& A)
&	F&	' " +_K )" )_K	(! A)

A). &\$w &?; : " 7A

...

... "%

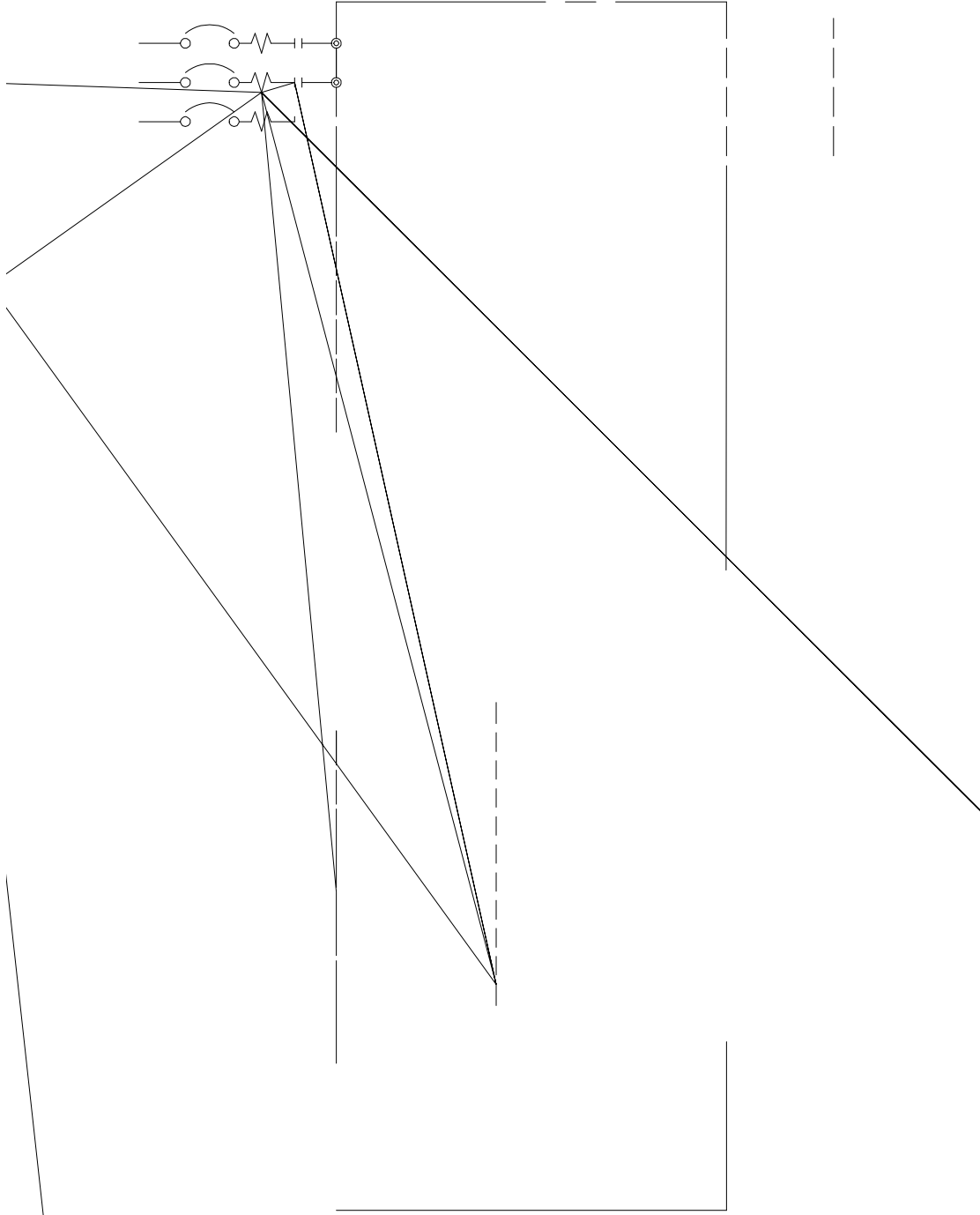

' "' &

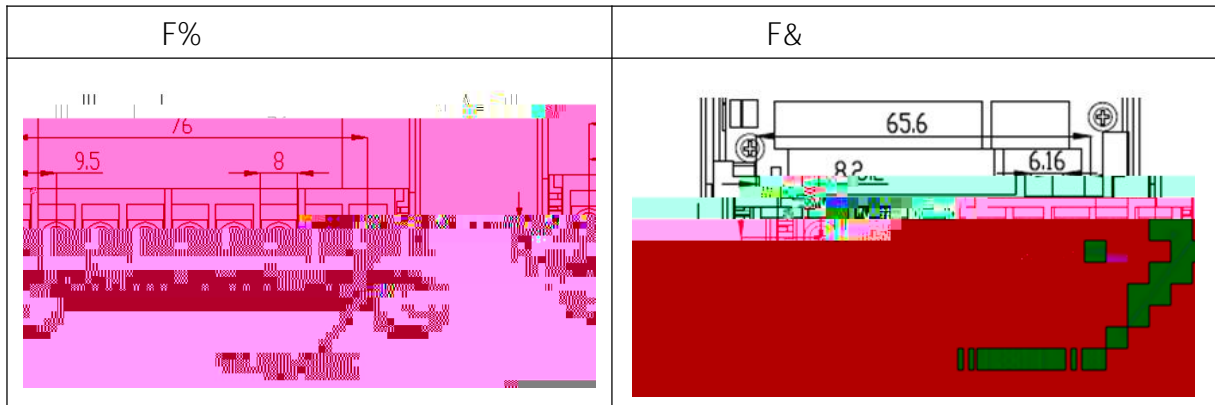

% F%F&

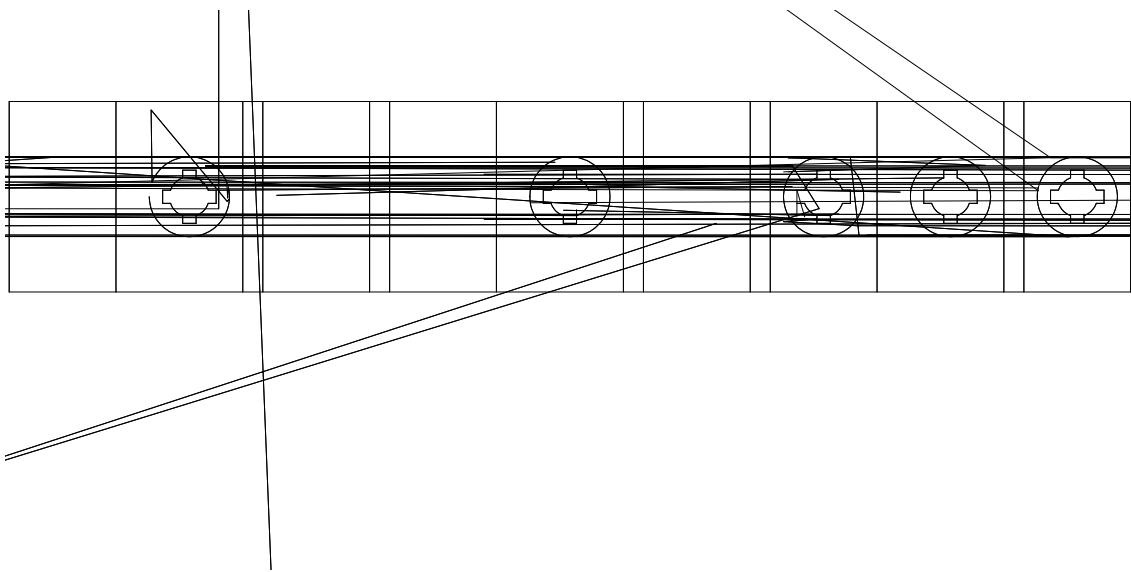

---

)

\*

+

N

' '' '(

;: '\* \$B\$%



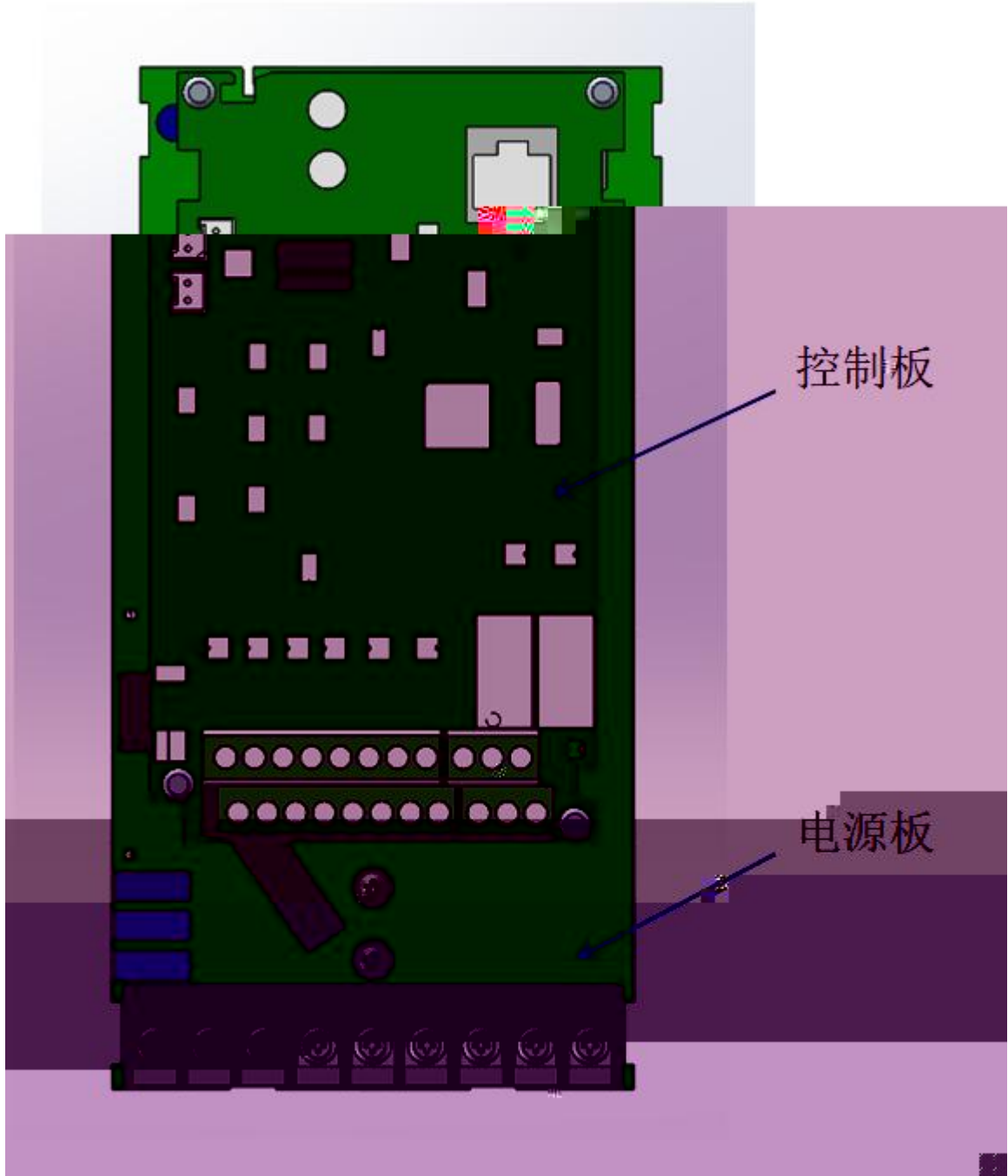



1

GUIDE

20

kkk" [XYhYwV

P

---

(

("%

; : \*' \$B\$%

@98

% @98

FI B

F9J

@C75@ #

9FF #

<N <n FDA

5 5 FDA I







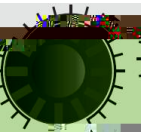

J J I

& @98 @98

) @98

@98

显示文字	LED显示	显示文字	LED显示	显示文字	LED显示	显示文字	LED显示
0	0	A	A	K	K	U	U
1	1	B	B	L	L	V	V
2	2	C	C	M	无	W	无
3	3	D	d	N	n	X	无
4	4	E	E	O	o	Y	Y
5	5	F	F	P	P	Z	无
6	6	G	G	Q	Q		
7	7	H	H	R	r		
8	8	I	I	S	S		
9	9	J	J	T	t		

		9G7
		
		
		Ž%
		!%
		
		
		
		#

(" & @98

%

@98

#

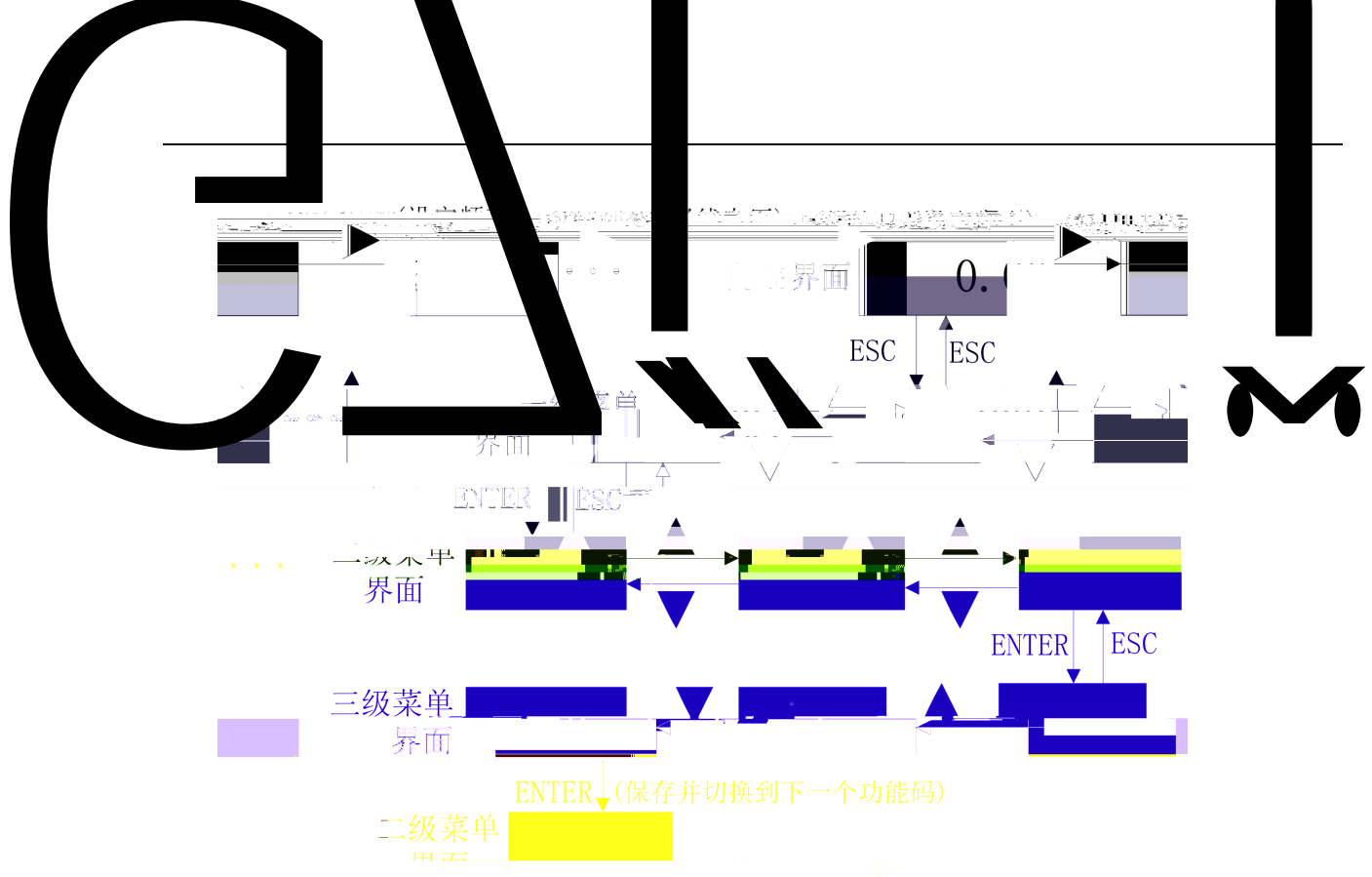

f1 七

D\$&" \$)

9G7

f1 七# f1 七

9G7

9BH9F

f1 七# f1 七

f1

七

f1/¥~

&

9G7

fl 七#

fl 七# fl 七#9BH9F

9BH9F

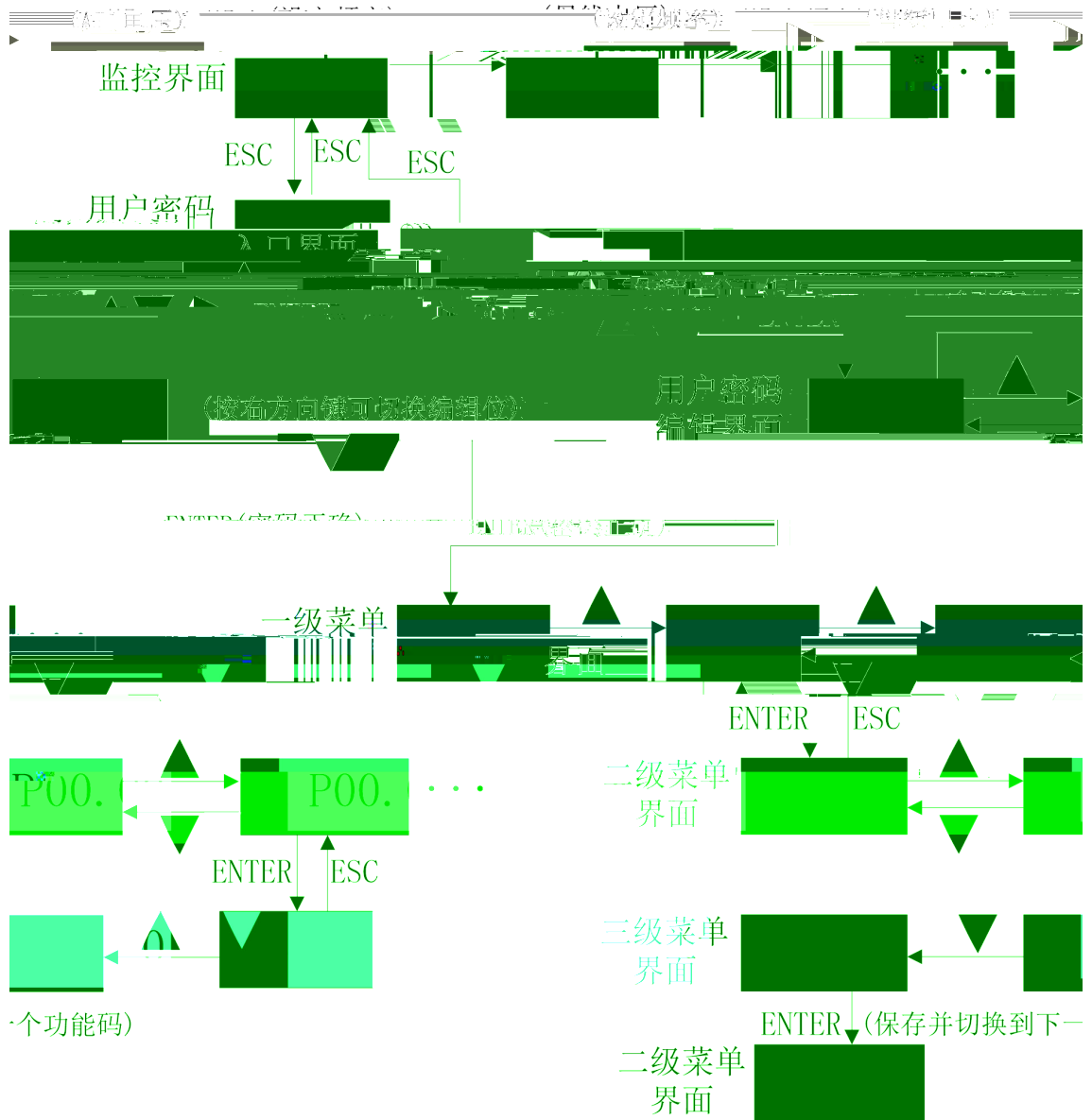

@98

#

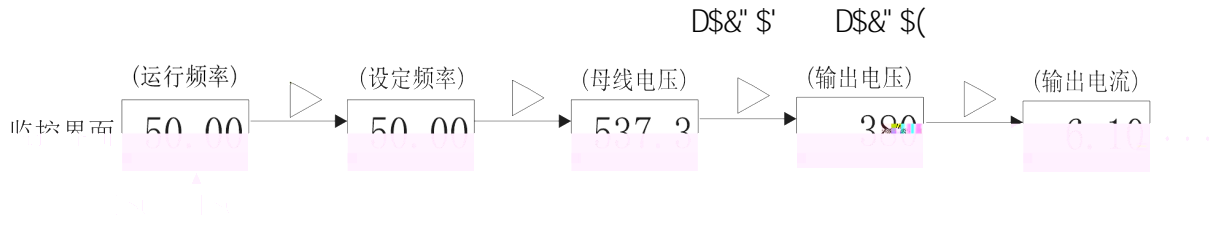

)

)"%

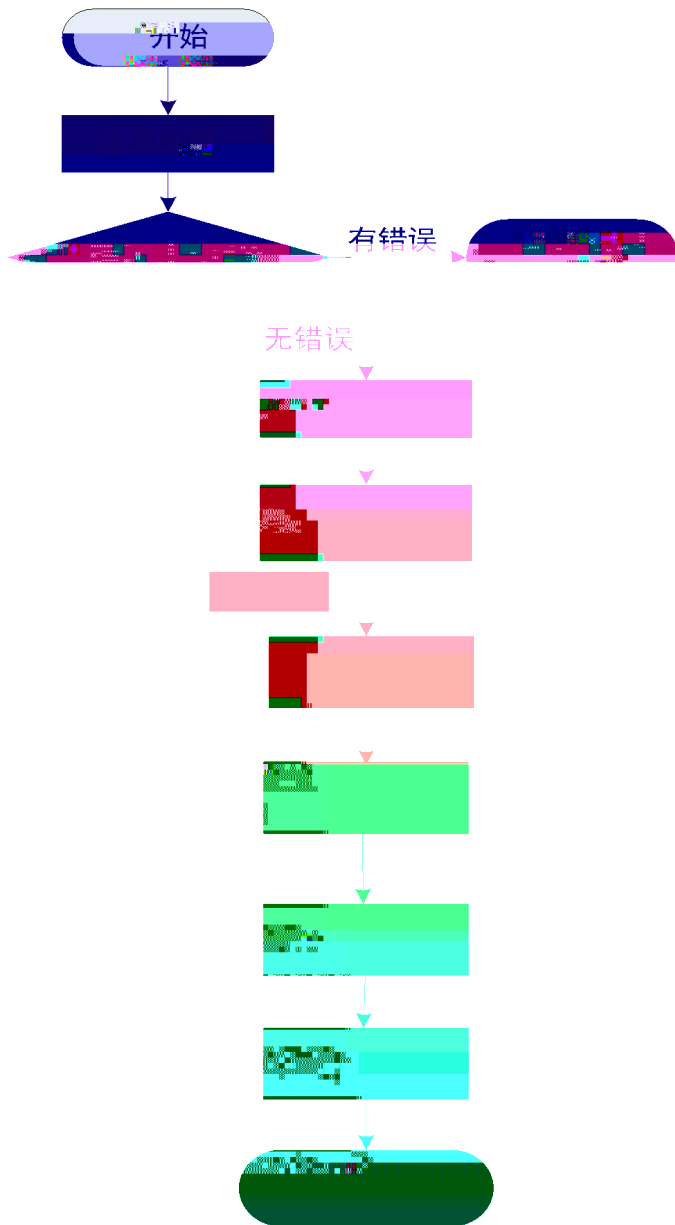



)" (

J#:

D\$, " %\$

f|<n|

# # #  
#



)")

	% &" D%\$" )' % 9BH9F HI B9 ' " FI B 9FF	% fID%\$" &&£/ &" fID%\$" &' £/ ' " fID%\$" &(£/
	% &" D%\$" )' & 9BH9F HI B9 ' " FI B 9FF	% fID%\$" &&£/ &" fID%\$" &' £/ ' " fID%\$" &(£/ ( " fID%\$" &) £/ )" fID%\$" &* £/

%

; : \*' \$B\$%

' (

	%#)
	D%\$

&

%		
&	@C75@	
,	I D#8CKB )<n	
(	FI B FI B	
)	( )\$<n	
*	GHCD	

,





\*" % D\$

D\$\$" \$\$		\$ *)')'	\$	
D\$\$" \$%		\$ \$% \$&	\$	
D\$\$" \$&	↳	D&' žD&+ \$ ž % D%žD% žD% žD& žD&- žD' \$ž % \$		
D\$\$" '\$				
D\$\$" \$(		\$ %	\$	

\*" & D&

D\$&" \$\$

\$ A: "  
%

D\$&" \$% A: "?

&  
,  
(  
\$ Ö2

D\$&" \$& GHCD



D\$&" '\$	@98 %	\$\$\$\$ : : : : 6] h\$\$ % <n 6] h\$% <n 6] h\$& J 6] h\$' . J 6] h\$( . 5 6] h\$) . _K 6] h\$* . I 6] h\$+ . 8= 6] h\$ , . 8C 6] h\$- . 5=% J 6] h%\$ . 5=& J 6] h%% 5=' fl Ł J 6] h%& 6] h% . 6] h%( . 6] h%) . D=8	%	
D\$&" \$(	@98 &	\$\$\$\$ : : : : 6] h\$\$ D=8 6] h\$% D@7 6] h\$& DI @G9 _<n 6] h\$' & <n 6] h\$( 6] h\$) 5=% J 6] h\$* 5=& J 6] h\$+ 5=' fl Ł J 6] h\$ , 6] h\$- <ci f 6] h%\$ A] b 6] h%% DI @G9 <n 6] h%& 6] h% <n 6] h%( L <n 6] h%) M <n	\$	

---

		\$\$\$\$ : : : :		
		6] h\$\$	<n	
		6] h\$%	J	
		6] h\$& 8=		
		6] h\$' . 8C		
		6] h\$( . 5=%	J	
D\$&" \$)	@98	6] h\$) . 5=&	J	..
		6] h\$* . 5=' fl	Ł	J
		6] h\$+.		
		6] h\$, .		
		6] h\$- . D@7		
		6] h%\$.		
		6] h%% D=8		
		6] h%& DI @G9		_<n
D\$&" \$*		\$" \$\$\$% ! Ł\$\$\$		



' %  
' &  
' '  
' (  
' ) D=8  
' \* %  
' + + &  
' , D=8  
' - L  
' (\$ M  
' (% %  
' (& &  
' ( D=8  
' (( %  
' () &  
' (€ #

p  
p

κβιλσδ λβη•γλ. η

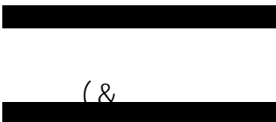

( &

**GUIDE**

kkk" [XYhYWWta

D\$' " %*	8=	\$ % 8=% 8=& 8=' 8=( 8=)	\$	
D\$' " %+				

\*" ( D(

D\$( " \$\$	<8C	\$ : AD % : AF	\$	
D\$( " \$%		\$ % & ' : 8H% ( ) % * +	\$	
D\$( " \$&	&	' - %\$ %% D@7 %& % % % % %* 5=% 5=&	&	

%+  
%  
%  
&\$  
&%  
&&  
&' &  
&( : 8H&  
&) : 8H&  
&\* %  
&+ &  
& %  
&- &  
' \$  
' % 5=%  
' &  
' '  
' (  
' )  
' \*  
● +

8



. 5=%

\$.

% \$" \$!

D) " &% 5=

5=&

\$

5='

||



GUIDE

kkk' l' mta

---

\*" +

D+

D\$+" \$\$

\$

fĹ

D\$+" %		<p>\$ % , ( , %% %) % &amp;% &amp;&amp; &amp;( ) &amp;*</p>		
D\$+" %		<p>&amp;+. % &amp; . &amp; &amp; . ' \$ ' % D=8 (\$ (% ( ) )% %\$\$ %\$\$% %\$\$&amp;</p>		
D\$+" %*		<p>%) %\$, %%\$ %%% %%&amp; %% %%( %%) %% %%. #D, %&amp;\$ %+\$ &amp;\$&amp;</p>		

D\$+" %+				
D\$+" %				
D\$+" %				
D\$+" &\$				
D\$+" &%				
D\$+" &&				
D\$+" &'				
D\$+" &(				
D\$+" &)				
D\$+" &*				
D\$+" &+				
D\$+" &				
D\$+" &-				
D\$+"'' \$				
D\$+"'' %				
D\$+"'' &				
D\$+"'' '				
D\$+"'' (				
D\$+"'' )				
D\$+"'' *				
D\$+"'' +				
D\$+"'' ,				
D\$+"'' -				

---

D\$+" (\$

D\$+" (%)

D\$+" (&

D\$+" ('

D\$+" ((

D\$+" ()

D\$+" (\*

~ fiž

)\$

**&**  
**CODE**

kkk" [XYhYWVča

---

% &+  
 \$  
 %  
 &  
 & &  
 \$  
 %  
 &  
 &-  
 \$  
 D\$+" (- ' % \$  
 &  
 ' \$  
 \$  
 %  
 &  
 +  
 D=8 ' %  
 \$  
 %  
 &  
 %&  
 \$  
 D\$+" ) \$ ( % \$  
 &  
 %&  
 )%

D\$+" ))		\$" \$! %&\$" \$! %&\$" \$!	%&\$" \$\$!	
D\$+" ) *		D\$, " %&		
D\$+" ) +				
D\$+" ) ,				
D\$+" ) -		\$ % &	\$	
D\$+" * \$		, \$" \$! %&\$" \$!	-\$" \$\$!	
D\$+" * %		\$" \$\$g %&\$" \$\$g	\$" ) \$g	
D\$+" * &		* \$" \$! %&\$" \$!	, \$" \$\$!	
D\$+" * '		\$ %	\$	
D\$+" * (		\$" \$ %&\$" \$	%&\$" \$\$!	
D\$+" * )		\$" \$ * \$" \$g	% \$g	
D\$+" * *				
D\$+" * +		\$" \$ ) \$" \$	&\$" \$\$!	
D\$+" * ,		\$" \$g * \$" \$g	% \$g	
D\$+" * -		\$" \$ ) \$" \$	&\$" \$\$!	
D\$+" * + \$		\$" \$g * \$" \$g	)" \$g	

\*" , D,

D\$, " \$\$				
D\$, " \$%	%	\$ GJ7 % & J#:	&	
D\$, " \$&		\$ @98 % @98 & @98	\$	
D\$, " \$'	L	\$ D\$, " \$, I D#8CKB % D\$, " \$, I D#8CKB	(	



		)		
D\$, " %&		D\$, " %(	D\$, " %\$	) \$" \$\$\$<n
D\$, " %		" \$\$\$<n	D\$, " %\$	" \$\$\$<n
D\$, " %(		" \$\$\$<n	D\$, " %&	" \$\$\$<n
D\$, " %)		" )_<n	% " \$_<n	
D\$, " %*		\$		%
D\$, " %+	%	" \$ \$g *	" \$ \$g	
D\$, " %	%	" \$ \$g *	" \$ \$g	
D\$, " %		\$ %		%
		% " %		
		& " \$ %		
D\$, " &\$				
D\$, " &%		" \$\$\$<n	D\$, " %\$	" \$\$\$<n
D\$, " &&		% " %<n		&
		& " \$ %<n		
D\$, " &'		\$		\$
		%		
D\$, " &(&		\$ %		\$
		% &		
		& '		
		' (		
D\$, " &)		\$	D\$, " %\$	\$
		%		
		& % \$\$\$<n		
D\$, " &*	I D#8CKB	\$		\$
		%		
D\$, " &+		\$		\$
		%		
		& 5=%		
		' 5=&		

---

( 5= ' fl Ł  
) DI @G9 8=)  
\*  
+ D@7  
, D=8  
-

D\$, " &

\$  
% \$  
&  
\$ "

D\$, " &-

D, 89.,  
#

\*" \_

D-

D\$- " \$\$		\$	\$
		%	
D\$- " %%		\$" \$! %\$\$" \$!	\$" \$\$!
D\$- " &		\$" \$! ) \$" \$!	\$" \$\$!
D\$- " '\$		\$" %g ' \$\$\$" \$g	%\$" \$g
D\$- " \$(		\$" % %\$\$" \$!	) \$" \$\$!
D\$- " \$)		\$a *)' ) a	%\$\$\$a
D\$- " \$*		\$a *)' ) a	\$a
D\$- " \$+		\$" % *)' " )	%\$\$
D\$- " \$,		% *)' )	%\$\$\$
D\$- " \$-		% *)' )	%\$\$\$
D\$- " %\$	\$	!%\$\$" \$! %\$\$" \$!	\$" \$\$!
D\$- " %%	%	!%\$\$" \$! %\$\$" \$!	\$" \$\$!
D\$- " %&	&	!%\$\$" \$! %\$\$" \$!	\$" \$\$!
D\$- " %'	'	!%\$\$" \$! %\$\$" \$!	\$" \$\$!
D\$- " %{(	(	!%\$\$" \$! %\$\$" \$!	\$" \$\$!
D\$- " %}	)	!%\$\$" \$! %\$\$" \$!	\$" \$\$!
D\$- " %*	*	!%\$\$" \$! %\$\$" \$!	\$" \$\$!
D\$- " %+	+	!%\$\$" \$! %\$\$" \$!	\$" \$\$!
D\$- " %,	,	!%\$\$" \$! %\$\$" \$!	\$" \$\$!
D\$- " %-	-	!%\$\$" \$! %\$\$" \$!	\$" \$\$!
D\$- " %&	%&	!%\$\$" \$! %\$\$" \$!	\$" \$\$!
D\$- " %%	%%	!%\$\$" \$! %\$\$" \$!	\$" \$\$!
D\$- " %&	%&	!%\$\$" \$! %\$\$" \$!	\$" \$\$!
D\$- " %'	%'	!%\$\$" \$! %\$\$" \$!	\$" \$\$!
D\$- " %{(	%{(	!%\$\$" \$! %\$\$" \$!	\$" \$\$!
D\$- " %}	%}	!%\$\$" \$! %\$\$" \$!	\$" \$\$!
		\$	
D\$- " %*	D@7	%	
		&	

) \*



---

D\$- " ) -	D@7 %)	\$ ' .	\$	
D\$- " * \$	D@7	\$ g % \	\$	
D\$- " * %	\$	\$ D\$- " % \$ % 5=% & 5=& ' 5=' fl t ( DI @G9 ) D=8 * D\$, " \$, I D#8CKB	\$	

\*" % \$ J#: % D% \$

	\$ J#:	
	% J#:	
	& J#:	
D% \$ " \$ \$ J:	' % & J#:	
	( % ( J#:	\$
	* % * J#:	
	, % , J#:	
	-	
	% \$ J:	
	% % J:	

D% \$ " \$ %	\$ " \$!	
	\$ " % ' \$ " \$!	

D% \$ " \$ &	\$ " \$ \$ < n	) \$ " \$ \$ < n
--------------	----------------	------------------

D% \$ " \$ ' J:	%	\$ " \$ \$ < n D% \$ " \$)	\$ " \$ \$ < n
-----------------	---	----------------------------	----------------

D% \$ " \$ ( J:	%	\$ " \$! % \$ \$ " \$!	\$ " \$ \$!
-----------------	---	------------------------	-------------

D% \$ " \$) J:	&	D% \$ " \$ ' D% \$ " \$ +	\$ " \$ \$ < n
----------------	---	---------------------------	----------------

D% \$ " \$ * J:	&	\$ " \$! % \$ \$ " \$!	\$ " \$ \$!
-----------------	---	------------------------	-------------

---

D%\$" \$+ J: ' D%\$" \$) D%\$" &\$ \$" \$\$<n

D%\$" \$, J: ' \$" \$! %\$\$" \$! \$" \$\$!

D%\$" \$- J:

---

D%\$" &\*

\$" \$%5

D%&" \$%	%	\$" \$%g %\$ " \$\$g	\$" ) \$g	
D%&" \$&	%	\$" \$\$ D%&" \$)	)" \$\$<n	
D%&" \$'	&	% %\$\$	&\$	
D%&" \$(	&	\$" \$%g %\$ " \$\$g	%" \$\$g	
D%&" \$)	&	D%&" \$&	%\$ " \$\$<n	
D%&" \$*		) \$! &\$ \$!	%\$ \$!	
D%&" \$+		\$" \$\$\$g \$" %\$\$g	\$" \$\$\$g	
D%&" \$,		\$ &\$	* (	
D%&" \$-		\$ D%&" %\$ % 5=% & 5=& ' 5=' fl t ( DI @G9 ) * A=Bf15=%z 5=&t + A5Lf15=%z 5=&t % + D%&" %\$	\$	
D%&" %\$		\$" \$! &\$ \$ \$!	% \$ " \$ \$!	
D%&" %%				
D%&" %&				
D%&" %		\$ * \$\$\$\$	&\$\$\$	
D%&" %(\		\$ * \$\$\$\$	% \$\$	
D%&" %)		\$ * \$\$\$\$	&\$\$\$	
D%&" %*		\$ * \$\$\$\$	% \$\$	
D%&" %+		\$ %	\$	
D%&" %				
D%&" %-				
D%&" %&\$		% ' \$ \$!	) \$!	
D%&" %&%		%\$! ) \$ \$!	%\$ \$!	
D%&" %&&		& %\$	&	

\*" % & D%

D% " \$\$	%	% %\$\$	' \$	
D% " \$%	%	" \$%g %\$ " \$\$g	" ) \$g	
D% " \$&	%	" \$\$ D% " \$)	) " \$\$<n	
D% " \$'	&	% %\$\$	&\$	
D% " \$(	&	" \$%g %\$ " \$\$g	% " \$\$g	
D% " \$)	&	D% " \$&	%\$ " \$\$<n	
D% " \$*		) \$! &\$ \$!	%\$ \$!	
D% " \$+		" \$\$\$g " %\$ \$g	" \$\$\$g	
D% " \$,		\$ &\$ \$	* (	
D% " \$-		\$ D% " %\$ % 5=% & 5=& ' 5=' fl t ( DI @G9 ) * A=Bf15=%z 5=&t + A5Lf15=%z 5=&t % + D% " %\$	\$	
D% " %\$		" \$! &\$ \$ " \$!	% \$ " \$ \$!	
D% " %%				
D% " %&				
D% " %		\$ * \$ \$ \$ \$	& \$ \$ \$	
D% " %Q		\$ * \$ \$ \$ \$	% \$ \$	
D% " %Q		\$ * \$ \$ \$ \$	& \$ \$ \$	
D% " %*		\$ * \$ \$ \$ \$	% \$ \$	
D% " %+		\$ %	\$	
D% " %				
D% " %				
D% " &\$		% ' \$ \$!	) \$!	
D% " &%		%\$! ) \$ \$!	%\$ \$!	

D% " &&		& %\$	&	
D% " &'	&	\$ GJ7 % & J#:	\$	
D% " &(	&	\$ % % % & & ' ' ( (	\$	
D% " &)		\$" \$! \$" % ' \$" \$!		
D% T" &*				
D% " &+		\$ %\$\$		

\*" %

D%

7 &



---

D% " %% D=8

" \$\$ \*) "\$ \$\$g

\$Yh Y



D% " %	J8C	\$ 8=I % (\$ D\$( 8C	\$	
D% " %	J8C(	\$ 8=I % (\$ D\$( 8C	\$	
D% " %	J8C)	\$ 8=I % (\$ D\$( 8C	\$	
D% " %*	J8C%	\$" \$g ' * "\$" \$g	\$" \$g	
D% " %+	J8C&	\$" \$g ' * "\$" \$g	\$" \$g	
D% " %	J8C	\$" \$g ' * "\$" \$g	\$" \$g	
D% " %	J8C(	\$" \$g ' * "\$" \$g	\$" \$g	
D% " &\$	J8C)	\$" \$g ' * "\$" \$g	\$" \$g	
D% " &%	J8C	\$ % J8C% J8C& J8C J8C( J8C)	\$	

\*\* %+

D%

D% " \$\$	5= (	! %\$" \$\$J D% " \$&	\$" \$\$J	
D% " \$%	5= (	! %\$\$" \$i Ž%\$\$" \$i	\$" \$\$i	
D% " \$&	5= ( %	D% " \$\$ D% " \$(	' " \$\$J	
D% " \$'	5= ( %	! %\$\$" \$i Ž%\$\$" \$i	' \$" \$\$i	
D% " \$(	5= ( &	D% " \$& D% " \$*	**" \$\$J	
D% " \$)	5= ( &	! %\$\$" \$i Ž%\$\$" \$i	*\$" \$\$i	
D% " \$*	5= (	D% " \$( Ž%\$\$" \$\$J	%\$" \$\$J	
D% " \$+	5= (	! %\$\$" \$i Ž%\$\$" \$i	%\$\$" \$\$i	
D% " \$,	5= )	! %\$" \$\$J D% " %\$	! %\$" \$\$J	
D% " \$-	5= )	! %\$\$" \$i Ž%\$\$" \$i	! %\$\$" \$\$i	
D% " %\$	5= ) %	D% " \$, D% " %&	! ' " \$\$J	

D% " %& 5= )	%	! %\$\$\$ \$! Z%\$\$\$ \$!	' " \$\$\$!
D% " %& 5= )	&	D% " %\$ D% " %&	' " \$\$\$!
D% " % 5= )	&	! %\$\$\$ \$! Z%\$\$\$ \$!	' " \$\$\$!
D% " %& 5= )		D% " %& Z%\$\$\$ \$!	%\$ " \$\$\$!
D% " %& 5= )		! %\$\$\$ \$! Z%\$\$\$ \$!	%\$\$\$ " \$\$\$!
D% " %*r			
D% " &			
D% " &( 5=%		! %\$\$\$ \$! %\$\$\$ " \$!	\$ " \$\$\$!
D% " &) 5=%		\$ " \$! %\$\$\$ " \$!	\$ " ) \$\$\$!
D% " &* 5=&		! %\$\$\$ \$! %\$\$\$ " \$!	\$ " \$\$\$!
D% " &+ 5=&		\$ " \$! %\$\$\$ " \$!	\$ " ) \$\$\$!
D% " & 5='		! %\$\$\$ \$! %\$\$\$ " \$!	\$ " \$\$\$!
D% " &- 5='		\$ " \$! %\$\$\$ " \$!	\$ " ) \$\$\$!
D% "' \$ 5=%	%	\$ " ) \$\$\$! ( " \$\$\$!	
D% "' % 5=%	%	\$ " ) \$\$\$! ( " \$\$\$!	
D% "' & 5=%	&	* " \$\$\$! - " ---!	
D% "' ' 5=%	&	* " \$\$\$! - " ---!	
D% "' ( 5=&	%	\$ " \$\$\$! &\$ " \$\$\$a5	
D% "' ) 5=&	%	\$ " \$\$\$! &\$ " \$\$\$a5	
D% "' * 5=&	&	\$ " \$\$\$! &\$ " \$\$\$a5	
D% "' + 5=&	&	\$ " \$\$\$! &\$ " \$\$\$a5	
D% "' ,			
D% "' -			

D% " (,				
D% " (-				

**\*" % D&\$**

D&\$" \$\$	#	\$ %	\$	
D&\$" \$%		\$ % D&\$" \$' % 5=% & 5=& ' 5' fl t ( ) * A=B 5=%& 5=& + A5L 5=%& 5=& % + D&\$" \$'	\$	
D&\$" \$&				
D&\$" \$'		! &\$ \$" \$i &\$ \$" \$i	% \$" \$ \$i	
D&\$" \$(		\$ % \$" \$\$	" \$" \$ \$i	
D&\$" \$)		" \$" \$<n	) \$" \$" \$<n	
D&\$" \$*		" \$" \$<n	) \$" \$" \$<n	
D&\$" \$+		" \$" \$g *) \$" \$" \$g	" \$" \$g	
D&\$" \$,		" \$" \$g *) \$" \$" \$g	" \$" \$g	

**\*" % D&%**

D&% "\$		" \$" \$<n	&" \$" \$<n	
D&% "\$		" \$" \$g *) \$" \$" \$g	&" \$" \$g	
D&% "\$		" \$" \$g *) \$" \$" \$g	&" \$" \$g	



---

D&% ' %	%	\$" \$i %\$\$" \$i	\$" \$\$i
D&% ' &		& \$" \$\$<n	) \$" \$\$<n
D&% ' ' &		\$" \$i %\$\$" \$i	\$" \$\$i
D&% ' (		\$" \$i ' \$\$" \$i %\$\$" \$i	)" \$\$i
D&% ' )		\$" %\$g * \$\$" \$\$g	\$" %\$g
D&% ' *		\$" \$i \$" % ' \$\$" \$i	&\$\$" \$\$i
D&% ' +		\$" \$\$g * \$\$" \$\$g	\$" \$\$g
D&% ' ,	%	\$" \$i ' \$\$" \$i	%\$\$" \$\$i
D&% ' -	%	\$" \$i ' \$\$" \$i	\$" \$\$i
D&% ( \$	&	\$" \$i ' \$\$" \$i	%\$\$" \$\$i
D&% ( %	&	\$" \$i ' \$\$" \$i	\$" \$\$i
D&% ( &		\$. %	\$
		\$ D&% ((j	
D&% ( ')			

⌘



D&' "%\$	5=& J # a5	" \$%J#\$" \$%a5	+\$5<	
D&' "%%	5=' fUŁ	" \$%J	+\$6<	
D&' "%&		%	+\$7<	
D&' "%		%	+\$8<	
D&' "%ł		%	+\$9<	
D&' "%Ń	D=8	%	+\$: <	
D&' "%*	D=8	%	+\$\$<	
D&' "%+	D@7	%	+\$%<	
D&' "%	DI @G9	" \$%<n	+\$&<	
D&' "%	fł<nŁ	" \$%<n	+\$% <	
D&' " & \$		" %A] b	+\$%<	
D&' " &%	5=%	" \$\$\$J	+\$% <	
D&' " &&	5=& J # a5	" \$\$\$J#\$" \$%a5	+\$* <	
D&' " &'	5='	" \$\$\$J	+\$%+<	
D&' " &(&		%a#A] b	+\$% <	
D&' " &)		%A] b	+\$% <	
D&' " &*		" %A] b	+\$%5<	
D&' " &+	DI @G9	%<n	+\$%6<	
D&' " &		" \$%	+\$%7<	
D&' " &-				
D&' "' . \$		" \$%<n	+\$%8<	
D&' "' %	M	" \$%<n	+\$% <	
D&' "' &		%	+\$& !	
D&' "' '				
D&' "' ('		%	+\$&&<	
D&' "' )	fłł Ł	" %ł	+\$&' <	
D&' "' *				
D&' "' +		" %ł	+\$&) <	

D&' "' ,				
D&' "' -	J:	%J	+\$&+<	
D&' " (\$	J:	%J	+\$& <	
D&' " (%	8=	%	+\$&- <	
D&' " (&	8C	%	+\$&5<	
D&' " ('	8= %f1 \$% (	%	+\$&6<	
D&' " ((	8C &f1 (% ,	%	+\$&7<	
D&' " ()		%	+\$&8<	
D&' " (*			+\$&9<	
D&' " (+r D&' ") +				
D&' " ),				
D&' " ) -	fll 7	\$" \$%	+\$' 6<	
D&' " *\$	fll 7	\$" \$%	+\$' 7<	
D&' " *%		%	+\$' 8<	
D&' " *&		%	+\$' 9<	
D&' " **		\$" \$%	+\$' : <	
D&' " *(		%	+\$(\$<	

\*" &% ' D&.

D&, " \$\$		\$ % &	\$	
D&, " \$%		\$" %_K *))' " )_K		
D&, " \$&		%J &\$\$\$J		
D&, " '\$		\$" \$%& *))' " ) 5 K \$" %& *))' " ) 5	01))_ 2))_K	

---

D&, " \$(

\$" \$%<n

D&, " \$)

%f da \*))' ) f da

\$" \$\$%

D&, " \$\*

D&- " '\$	\$" \$%& *)) "' )5 K \$" \$%& *)) "' )5	01))_ 2))_K
D&- " \$(	\$" \$%<n	
D&- " \$)	%f da *))' ) f da	
D&- " \$*	\$" \$\$\$% *))' ) ))_K \$" \$\$\$% *))' ) ))_K	01 2
D&- " \$+	\$" \$\$\$% *))' ) ))_K \$" \$\$\$% *))' ) ))_K	01 2
D&- " \$,	\$" \$%& < *)) "' ) a< )_K \$" \$%& < *)) "' ) a< )_K	01) 2)
D&- " \$-	\$" %& < *)) "' ) a< _K \$" \$%& < *)) "' ) a< _K	01)) 2))
D&- " %\$	\$" \$%& D&- " '\$ K \$" \$%& D&- " '\$	01))_ 2))_K
D&- " %%		
D&- " ' *		
D&- " ' +	\$ % &	\$

---

\*" &

'

D \$

\$

D \$" \$\$

%

% %\$\$

' \$

D\$\$" \$%

%

\$" \$%g %\$\$" \$\$\$g

\$" ) \$g

D \$" \$&

%

\$" \$\$ D' \$" \$)

)" \$\$<n

D \$" \$'

&

% %\$\$

&\$

D \$" \$(

&

\$" \$%g %\$\$" \$\$\$g

%" \$\$\$g

D \$" \$)

&

D \$" \$&

%\$\$" \$\$<n

D \$" \$\*

) \$! &\$\$!

%\$\$!

D \$" \$+

\$" \$\$\$g \$" %\$\$g



\$ D' %' %\$  
 % 5=%  
 & 5=&  
 ' 5=' C  
 ( DI @G9 ! C  
 ) \$  
 \* A=Bf15=%z 5=&t  
 + A5Lf15=%z 5=&t  
 ? + D' %' %\$

D' %' %\$ "\$ \$! &\$ \$" \$! % \$" \$ \$!

D' %' %%

D' %' %&

D' %' % \$ \*\$\$\$\$ &\$\$\$\$

D' %' % \$ \*\$\$\$\$ % \$\$

D' %' % \$ \*\$\$\$\$ &\$\$\$\$

D' %' % \$ \*\$\$\$\$ % \$\$

D' %' %+ \$ \$  
%

D' %' %

D' %' %

D' %' &\$ % ' \$ \$! ) \$!

D' %' &% % \$! ) \$ \$! % \$ \$!

D' %' && & %\$ &

D' %' & ( \$ GJ7

D' %' & ( % \$  
& J#:

D' %' & (

D' % &)		\$" \$1 \$" % ' \$" \$1		
D' % &*				
D' % &+		\$ %\$\$		

---

+  
+" %      D\$

D\$\$" \$\$			\$
		\$ *))' )	

D\$\$" \$\$

D\$\$" \$\$    \$\$\$\$\$

\$

\$

D\$\$" \$%

%

&





A: " ?

8000 0.50 0.250 0.60  
A: ? :>C;

A: " ?

F>C;





D@7  
DI @G9

fL<nL

D\$&" \$(

\$\$\$\$  
::::

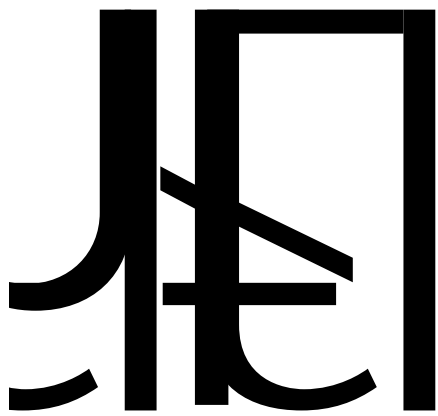

=7



D\$&" \$\*

\$

% \$\$\$\$

, \*

**GUIDE**

kkk" [XYhYWWta

---

D\$&" \$+			\$
		\$" \$ %\$"\$ \$	

=; 6H

=; 6H

D\$&" \$-			\$\
		\$\ *))' )\	

D&%" %+

%& CB

D\$&" %%			
D\$&" %&			%
		\$	\$
		%	%
		&	&
		,	,

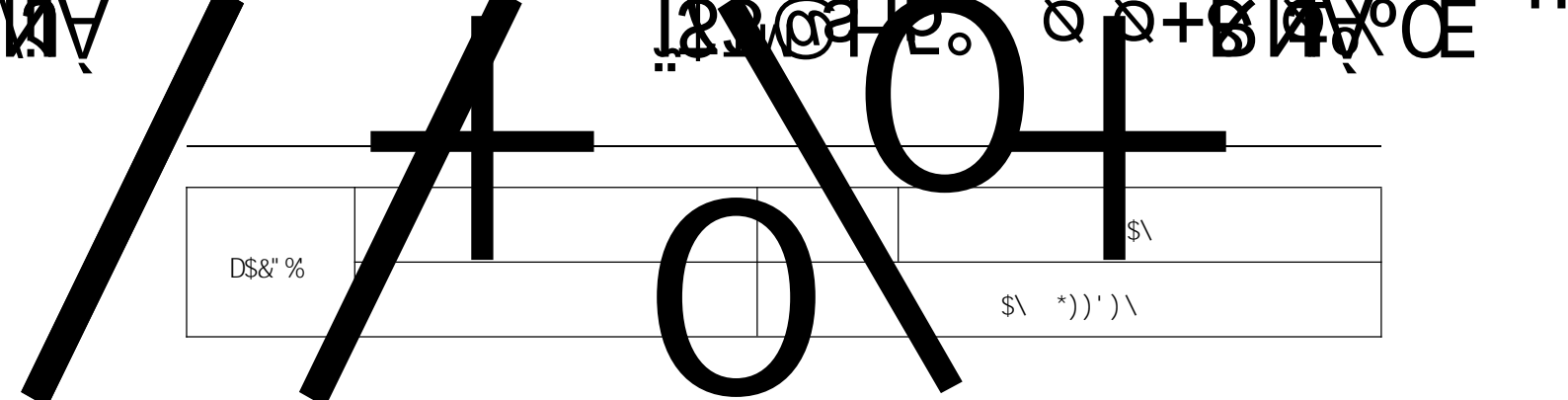

D\$&" %	\$\ '	\$\ *))' )\ '

D&% " %+

&( CB

D\$&" %

---

(

:>C;

:>C;

F>C;

---

D\$, \$\$,

&\$



*	%	\$	%	\$
+	\$	%	%	\$
,	%	%	%	\$
-	\$	\$	\$	%
/%	%	\$	\$	%
%%	\$	%	\$	%
%&	%	%	\$	%
%	\$	\$	%	%
%{	%	\$	%	%
%}	\$	%	%	%
%*	%	%	%	%
	\$	C : %	CB	

&	%		
C :	C :	%	D\$, " %+ D\$, " %
C :	CB	&	D&% \$' D&% \$(
CB	C :	'	D&% \$) D&% \$*
CB	CB	(	D&% \$+ D&% \$,

&	%		
C :	C :	%	D%\$ D%&
C :	CB	&	D%%

D\$ " %\$	8=		\$" %\$g
			\$" \$\$\$g % \$\$\$g

8=

8=

---

D\$ " %%

8=l	%	: K8
8=m	&	F9J
8=b	,	

8=b      8=l      8=m

8=l      8=b      8=m      8=b      8=l      8=m      8=b      8=%      8=%\$

&      8=b      8=l      8=m

%      : K8

---

D\$ " %	8=%	\$" \$g
		\$" \$g ' * \$\$" \$g
D\$ " %	8=&	\$" \$g
		\$" \$g ' * \$\$" \$g
D\$ " %	8='	\$" \$g
		\$" \$g ' * \$\$" \$g

D\$(" " \$%	: AF		\$
D\$(" " \$&	&		&
D\$(" " '\$			\$
D\$(" " \$(	%		%
D\$(" " \$)			(

) )

\$

%

CB

&

CB

'

: 8H%

D&%" % D&%" &\$

(

D&%" &%"

)

\$

CB

C: :

\*

---

%\$

D\$- " \$)

CB

%% D@7

D@7

&) \$ag

%&

D&%" %t

CB

%

54

---

&+

---

---

8C

\$\$\$\$

---

: AF

\$

%

D\$( " %%

&

\$ %

%

\$ %

q p 8

kkk" [XYhYWWta

---

**GUIDE**

--

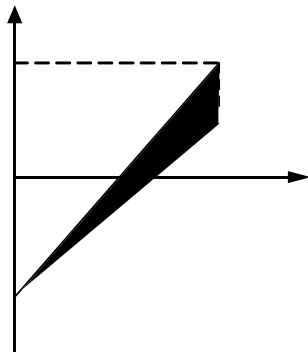
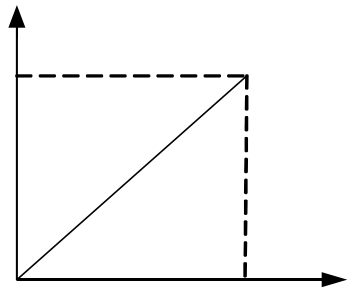



D\$) " %	DI @G9		%\$\$" \$i
		! %\$\$" \$\$i %\$\$" \$i	
D\$) " %	DI @G9		" %\$\$g
		\$" \$\$g %\$" \$\$g	

8=)

8=) % %

5= ' &%

D\$) " &\$

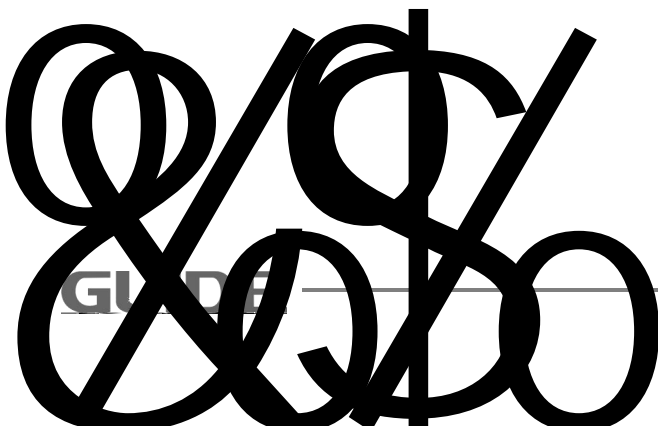

D\$) " &%	5=		\$\$\$
			5=%
		\$	
		%	\$" \$i
		5=&	\$ %
		5='	\$ %

5=% 5=& 5='

\$ 5=

D\$) " \$% D\$) " \$\* D\$) " %%

% 5=

\$" \$i

+ " \*

D\*

D\$* " \$\$	: AD		\$
D\$* " \$%	5C%		\$

: A D

\$ " \$ % \_ < n r D\$\* " \$' : A D

D\$\* " \$'

\$" \$%\_<n r) \$" \$\$\_<n

5C%

\$J %\$J

\$a5 &\$a5

---

\* DI @G9                    \$" \$%\_<n ) \$" \$\$\_<n

+ 5=%                        \$J %\$J

, 5=&                        \$J %\$J            \$ &\$a5

- 5='                         \$J %\$J

%\$                            \$

%%                            \$

%&                          \$" \$i    %\$\$" \$i

%                             \$

+" +

D+

D\$+" \$\$			%
		\$	
		%	
D\$+" \$%			% \$\$
			\$" &\$ %\$" \$\$

D\$+" \$\$1\$

D\$+" \$\$1%

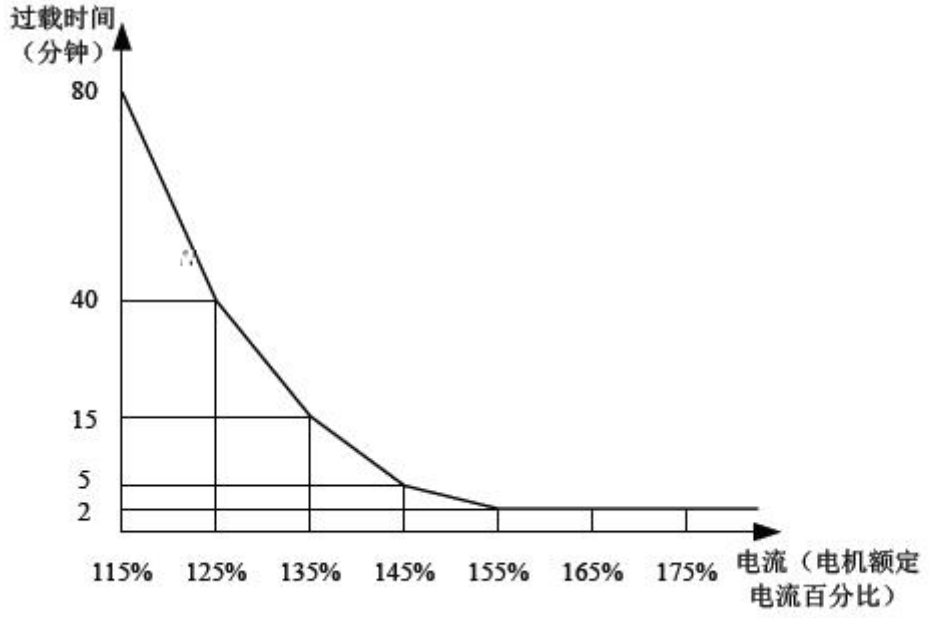

%&\$

' \$

' \$

=

D\$+" \$&			, \$l
		) \$l %\$\$l	

8C

8C

CB

D\$+" \$&

D\$+" \$'

\$

%\$\$

D\$+" \$(

% \$l

%&\$l % \$l



---

D\$+" %\$	8C		%
			\$ %

8C

D\$+" %\$

D\$+" %%			% \$g
			\$" %g %\$\$" \$g

D\$+" %&



D\$+" (+			%		\$\$\$\$\$	
				9\$%%		
		\$				
		%				
		&				
				9%%		
				9%{		
				9\$%)		
				9\$&&&		
D\$+" (,			&		\$\$\$\$\$	
				9%%		
		\$				
		%	J:			
		&	J:			
				9\$&%		
		\$				
		%				
				9%%%	D\$+" (+	
				9\$()	D\$+" (+	
				9ff&*	D\$+" +	

D\$+" (-			\$\$\$\$\$
		% 9\$&+	D\$+" (+
		& 9\$&	D\$+" (+
		9\$&-	D\$+" (+
		9\$' \$	
	\$		
	%		
	&	+!	
	D=8	9\$' %	D\$+" (+
D\$+" ) \$	(		\$\$\$\$\$
		9%&	D\$+" (+
		9%&	D\$+" (+
		9\$) %	D\$+" (+
		9\$) &	D\$+" (+

9! †

5! †

9! †

5! †

D\$+" ) (

D\$+" ) (			\$
		\$	
		%	
		&	
		.	
	(		

D\$+"))			%\$\$" \$i
			\$" \$i %\$\$" \$i

5t t D\$+" ) (

D\$+" ) )

\$

D\$+" ) -

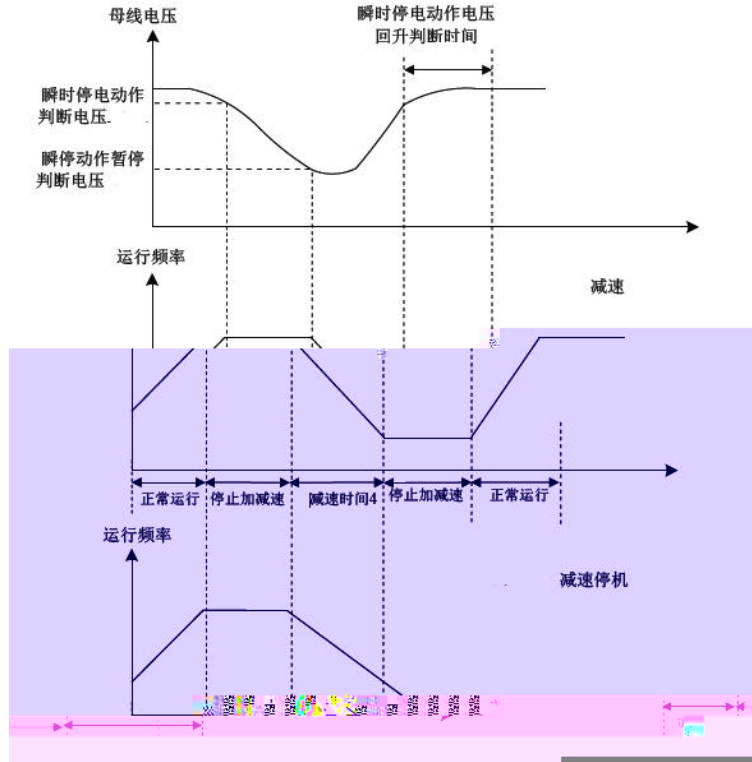

			\$
D\$+"**'		\$	
		%	
D\$+"*(			%" \$l
		\$" \$l	%"\$"\$ \$l
D\$+"*)			%" \$g
			\$" \$g * "\$ \$g

D\$+"\*) D\$+"\*( +l

---

---

D\$+"\*+

% "\$i

\$" \$i ) "\$ \$i

D\$+"\*,

% \$g

\$" \$g \* "\$ \$g

%

& J#:

D%&

&

D%

D\$, " \$&			\$
		\$	@98
		%	@98
		&	@98

\$

@C75@

FI B GHCD#F9G

%

@C75@

: K8 F9J >C; : >C; F

&

@C75@#F9ACH

D\$, " '\$	L		\$
		\$	D\$, " \$, I D#8CKB
		%	D\$, " \$, I D#8CKB
		&	5=%
		'	5=&
		(	5='
		)	8=)
		*	
		+	D@7





			M
L	D\$, " '\$	D\$, " \$(	
	M		\$
D\$, " \$)	\$		
	%		L
D\$, " \$*	M		\$
		\$l	% \$l

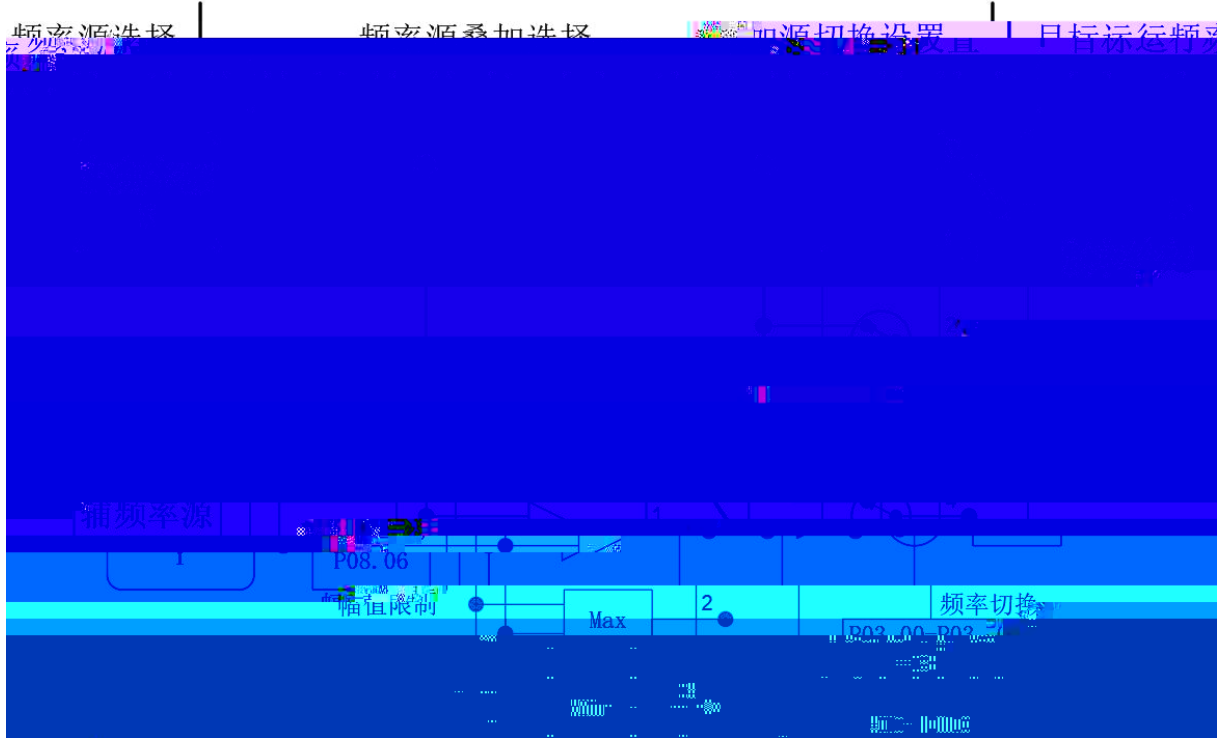

\$ L  
 L  
 %  
 & L M %  
 L %  
 M  
 ' L %  
 L %  
 ( M %  
 M %  
 \$ L M  
 L M  
 % L M  
 L M  
 & A5L L M L M

---

D\$, "\$,

)\$"\$<n

%%\$! D\$, " %&

D\$, " %&			)" \$\$\$<n
		D\$, " %& D\$, " %&	
D\$, " %			" \$\$\$<n
		" \$\$\$<n D\$, " %&	

DI @G9 D\$, " %

D\$, " %&

D\$, " %&			" \$\$\$<n
		" \$\$\$<n D\$, " %&	

D\$, " %&

D\$, " %*			\$
			\$ %

D\$, " %+	%		
			\$" \$\$g *) \$\$" \$g
D\$, " %	%		
			\$" \$\$g *) \$\$" \$g

D\$, " &)

h%

D\$, " &)

h&

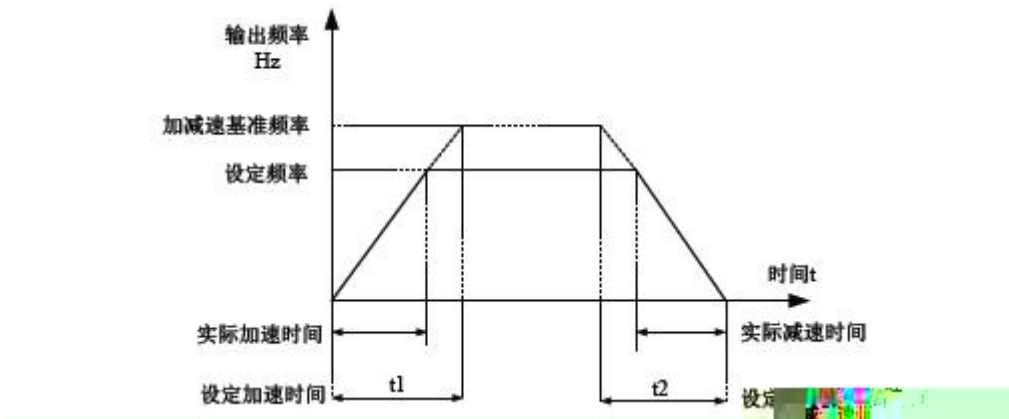

; : \*' \$B\$% (

8=

D\$, " %+ D\$, " %

D&% '\$ D&% '\$(

D&% '\$) D&% '\$\*

D&% '\$+ D&% '\$,

D\$, " %			%
		\$	%
		%	\$" %
		&	\$" \$%

;: '\*' \$B\$% ' % \$"% "\$ \$%

D,

D\$, " &%			" \$<n
			" \$<n D\$, " %\$

D, " &%

D\$, " &&			&
		%	" %<n
		&	" %<n

" %<n ;: '\*' \$B\$% ) \$<n  
 "\$ %<n ;: '\*' \$B\$% ) "\$ \$<n

D\$, " &			\$
		\$	
		%	

D\$, " \$,

I D 8CKB

I D 8CKB







D\$, "' )			\$
		\$	
		%	G 5
		&	G 6

\$  
% G 5 G  
G D\$, "' \* D\$, "' +  
G

$$t = \left(\frac{4}{9} \times \left(\frac{f}{f_b}\right)^2 + \frac{1}{9}\right) \times T$$

Z Z V H \$ Z V

D\$, "' \* G '\$" \$! \$" \$! %\$\$" \$! D\$, "' +  
G D\$, "' +



---

B

---

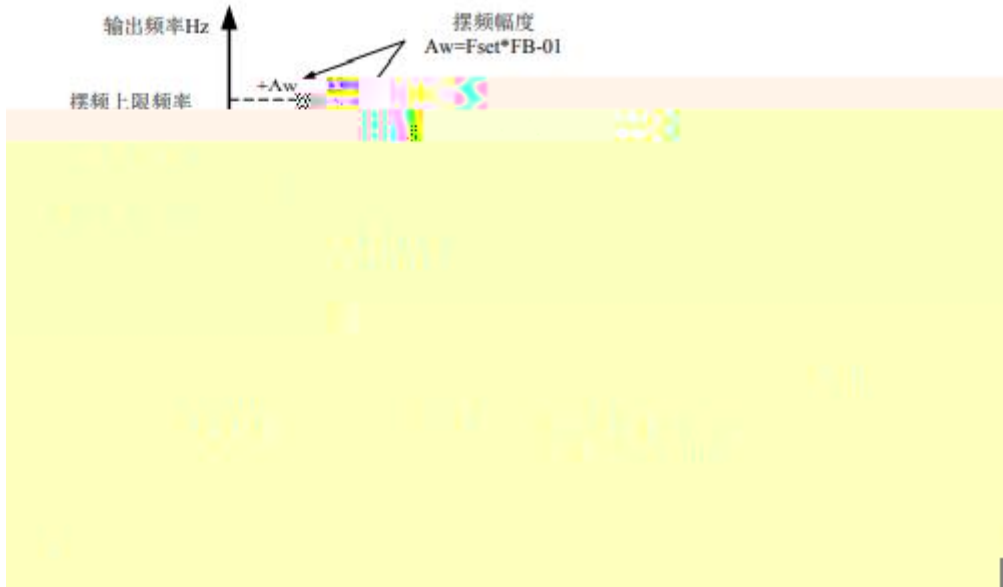

D\$- " \$\$			\$
		\$	
		%	

\$  
%

D\$- " \$%			" \$!
			" \$! %\$ " \$!
D\$- " \$&			" \$!
			" \$! ) " \$!

D\$- " \$\$\$ \$ 5K y D\$- " \$%  
D\$- " \$\$\$1% 5K y D\$- " \$%

5Ky D\$- " \$& D\$- " \$\$\$1\$  
D\$- " \$\$\$1%

D\$- "\$'			%\$" \$g
			\$" \$g ' \$\$\$" \$g
D\$- "\$('			) \$" \$i
			\$" \$i %\$\$" \$i

D\$- "\$('

D\$- "\$'

D\$- "\$' y

D\$- "\$('

D\$- "\$' y %

D\$- "\$('

%\$\$\$\$a

D\$- "\$)

\$a \*)))' )a

\$a

D\$- "\$\*

\$\$\$ ' )a

b

---

		! %\$\$" \$! %\$\$" \$!
D\$- " %t	+	\$" \$!
		! %\$\$" \$! %\$\$" \$!
D\$- " %	,	\$" \$!
		! %\$\$" \$! %\$\$" \$!
D\$- " %	-	\$" \$!
		! %\$\$" \$! %\$\$" \$!
D\$- " &\$	%\$	\$" \$<n
		! %\$\$" \$! %\$\$" \$!
D\$- " &%	%%	\$" \$!
		! %\$\$" \$! %\$\$" \$!
D\$- " &&	%&	\$" \$!
		! %\$\$" \$! %\$\$" \$!
D\$- " &'	%	\$" \$!
		! %\$\$" \$! %\$\$" \$!
D\$- " &(	%( )	\$" \$!
		! %\$\$" \$! %\$\$" \$!
D\$- " &)	% )	\$" \$!
		! %\$\$" \$! %\$\$" \$!

J:

D=8

! %\$\$" \$! r %\$\$" \$!

J:

D=8

D=8

8=

D'



D%\$" &*			
		\$" %5 D%\$" % \$" %5 D%\$" %	01))_K 2))_K

D%\$" && D%\$" &\*

D%\$" && D%\$" &(

)

D=

D%\$" %+

D%\$" %

D%\$" &&

D%\$" &\*

)

M

D%\$" )'			\$
		\$	
		%	
		&	

\$

%

D%\$" %\*rD%\$" &%

D%\$" && D%\$" &(

% F I B

&

D&%" \$&			&\$" \$g
			\$" \$g *) \$\$" \$g

D\$, " & 1 \$

D\$, " ' , 1\$

D&%" \$'	&		&\$" \$g
			\$" \$g *) \$\$" \$g

D&%" \$(	&		&\$" \$g
			\$" \$g *) \$\$" \$g

D&%" \$)	'		&\$" \$g
	(	€	\$" \$g *) \$\$" \$g

D&%" \$*	'		*) &\$" \$g
	(		\$" \$g *) \$\$" \$g

D&%" \$+	(		&\$" \$g
			\$" \$g *) \$\$" \$g

D&%" \$,	(	â	&\$" \$g
			\$" \$g *) \$\$" \$g

\* s AN,SI!o.人@Ð

8

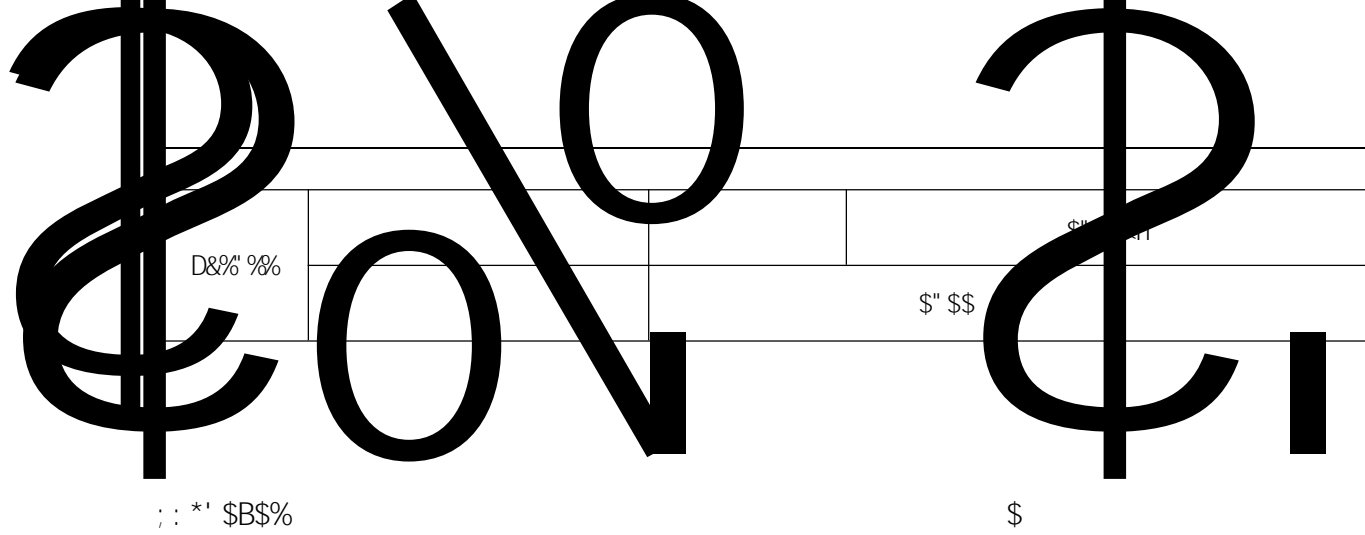

D&% %&			\$" \$g
		\$" \$\$\$g ' \$\$\$" \$g	

\$<n

D&% %

\$

\$

%,

D&%" %			\$
		\$	
		%	
		&	

D&%" &&			\$
		\$	%

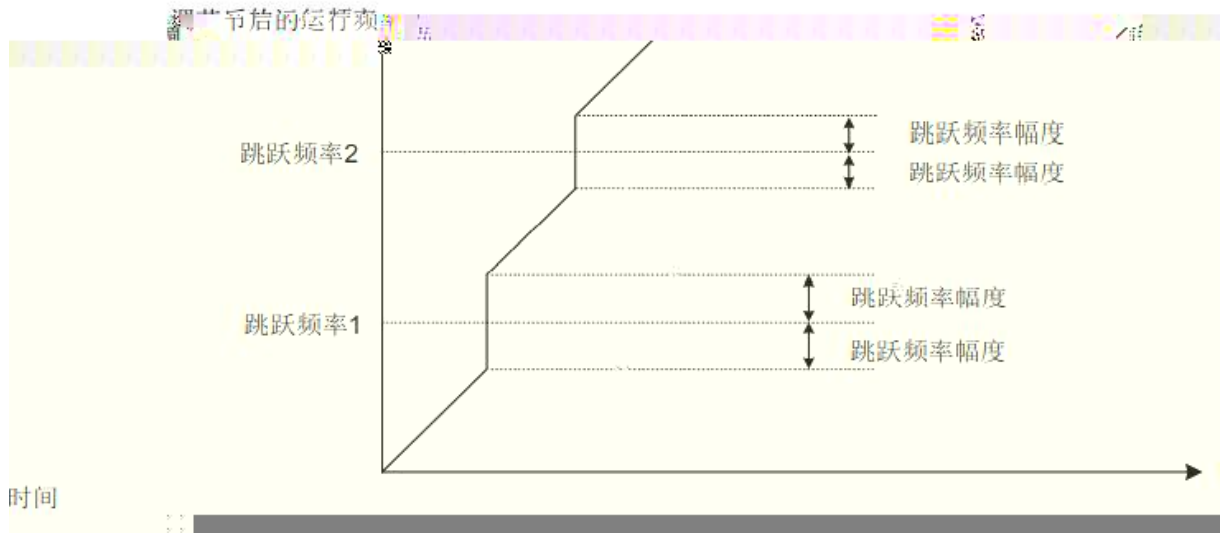

D&%" &)	%	&	\$" \$\$\$<n
			\$" \$\$\$<n
D&%" &*	%	&	\$" \$\$\$<n
			\$" \$\$\$<n

% 8=  
8=



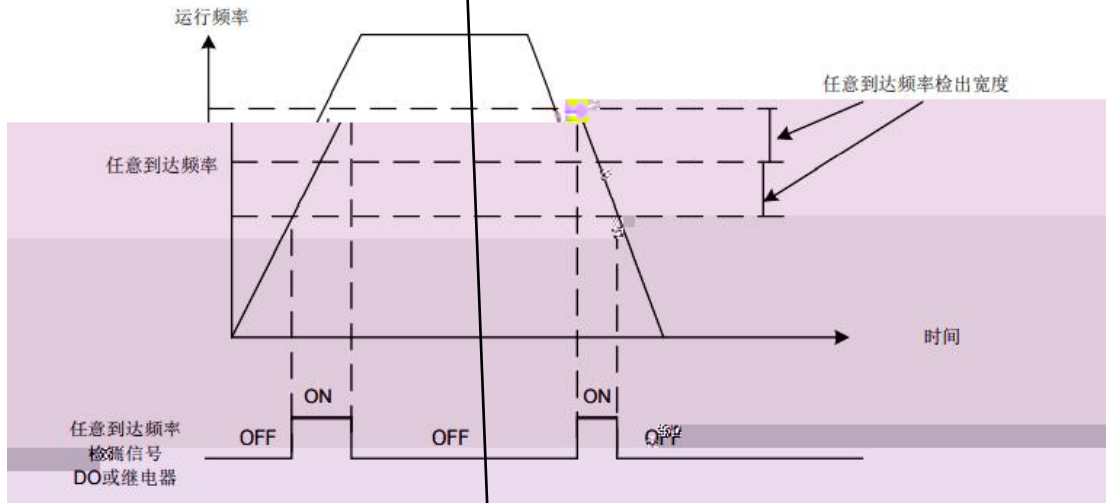

				\$
D&%" (&		\$		
		%		
D&%" ('				\$
		\$		D&%" ((
		%		5=%
		&		5=&
		'		5='
			%\$ \$i	D&%" ((
D&%" ((				\$" \$A] b
				\$" \$A] b * ) \$ \$ " \$A] b



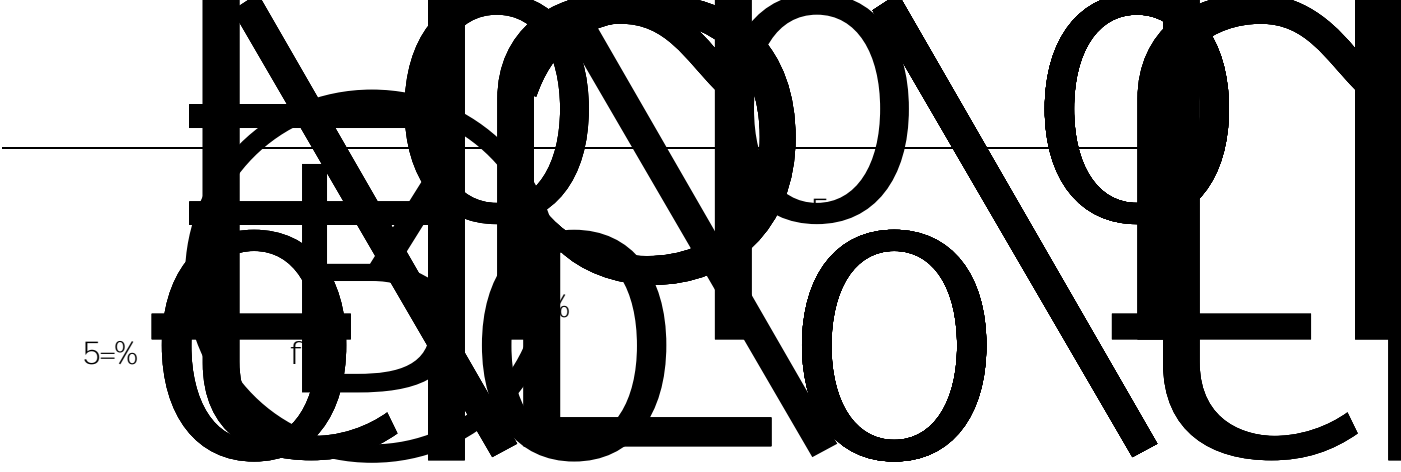

5=%

f

6



% (

**GUIDE**

kkk" [XYhYwVta





	%		%
	&		&
9%\$\$	,		,
	(		(
	%		%
	&		&
9%\$%	,		,
	(		(
	%		%
9%\$&	&		&
	%		%
	&		&
9%\$)	,		,
	(		(
	)		)
	*		*
	%		%
9%\$,	&		&
	%		%
	&		&
	,		,
9%/\$	(		(
	)		)
	*		*
	+	J#:	+
	,		,

	%		%
	&		&
9%0(	,		,
	(		(
	%		%
9%0)	&	D\$+" * +	&
	D\$+" *		
	%		%
9%0%	&	D\$+" * -	&
	D\$+" +\$		
	%		%
	&		&
9%&\$	,		
	(		
	)		



kkk" [XYhYW Vta

**GUIDE**

---

-

%

---

- "&

	% &"	% 2 (\$ 0 - ) &"
	% &"	% &"
	% &" ' "	% &" ' "
	% &"	% &"
	% &"	% &"

\_" "

		% &
D76		

ND p° 9l  
p  
(200 n0 0K (e +e) n



%  
&  
,

Ki \Ub ; i ] XY HYW\bc` c[ m 7c" ž@hX"