

HF 680NLC

690V

160~1935kW

1.07

Wuhan GUIDE Technology Co., Ltd

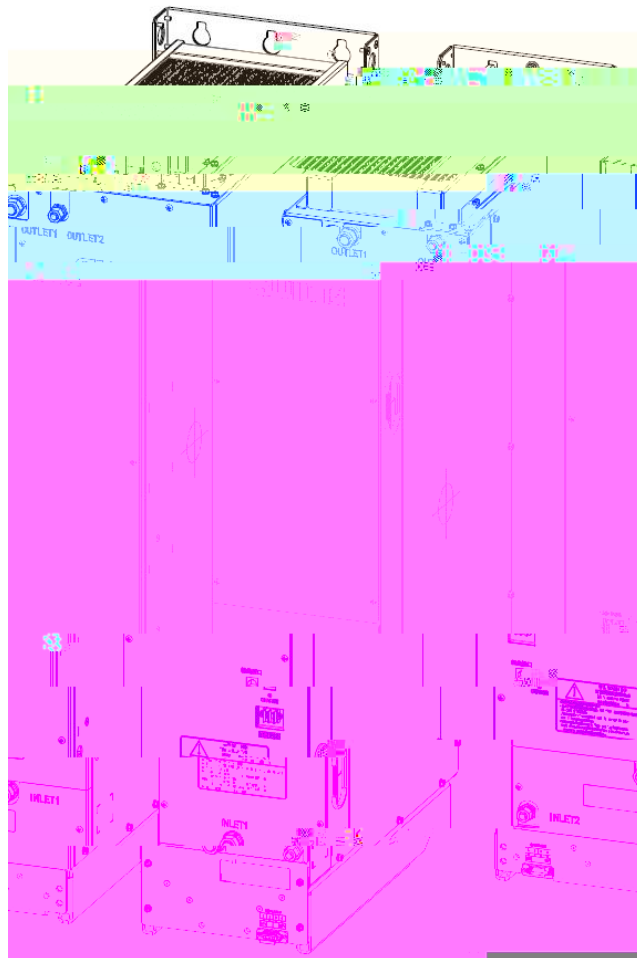

HF680NLC

1.

1.1

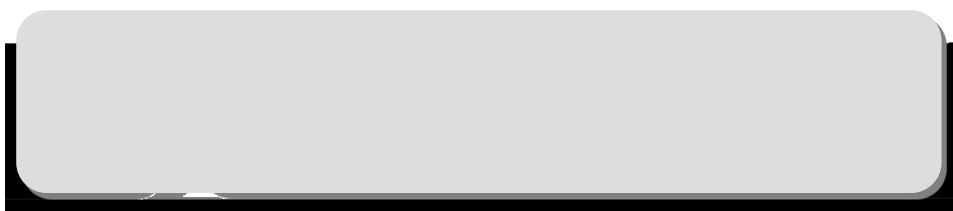

1

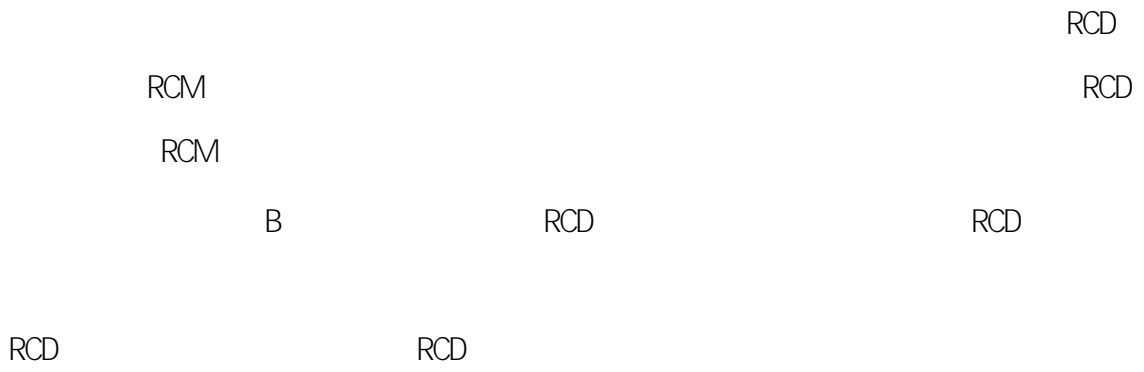

2

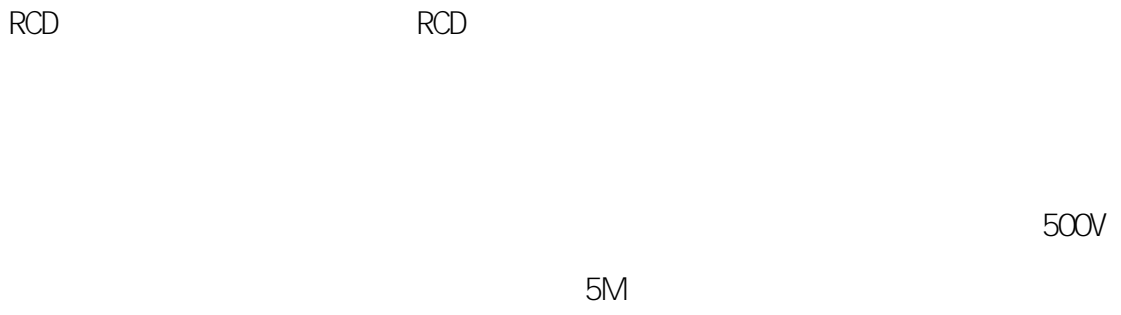

3

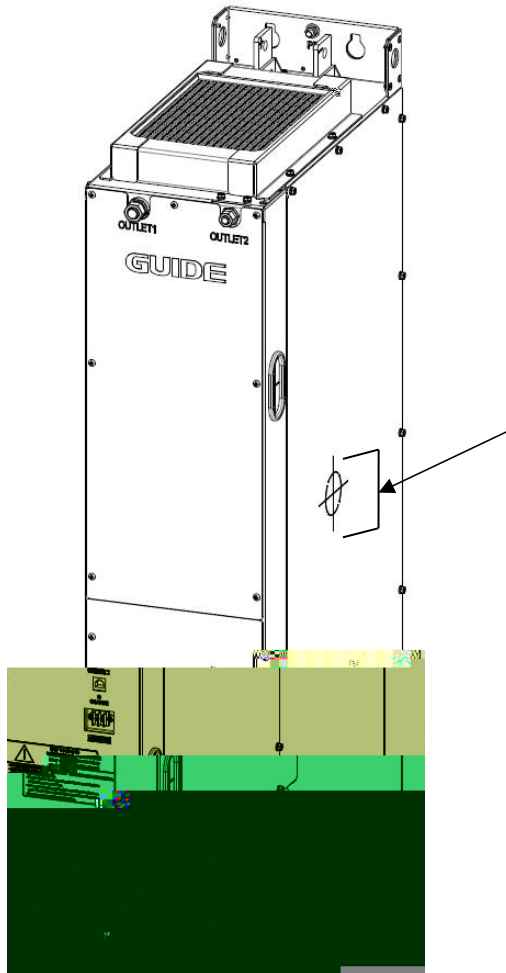

HF680NLC-560-6

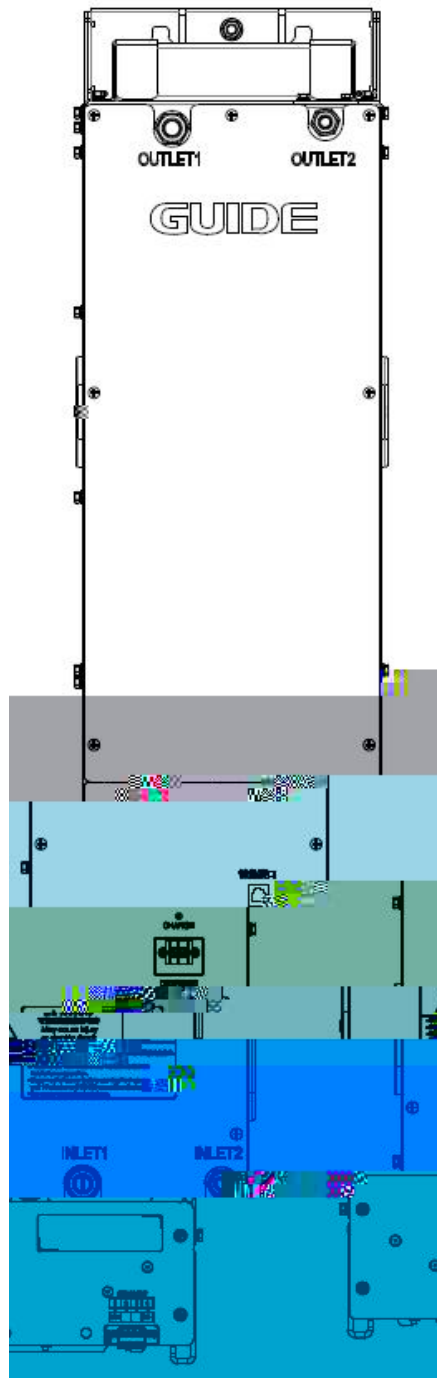

HF61

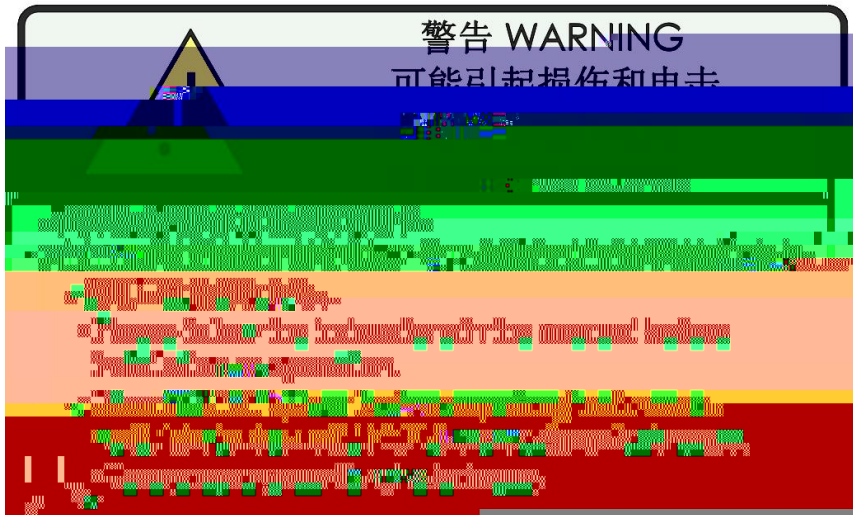

1.2

(1)

(2)

(3)

1.3

2

2.1

HF680NLC

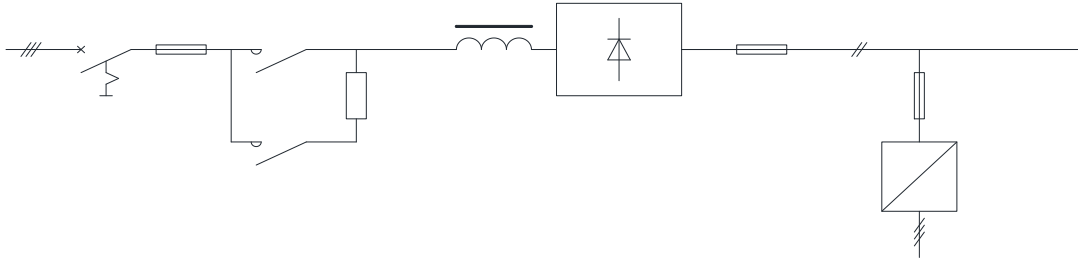





		GDHF - AKZY1	LCD	HF680NLC01M
	GDHF - AKZY1		HF680NLC03M	
2			2. 8*8. 8 2	HF680NLC01M
	2. 8*8. 8 2		HF680NLC03M	
		2		
4		GDHF - KL4	4	HF680NLC01M
	GDHF - KL4		HF680NLC03M	4
			1	HF680NLC01M
	GDHF - FB01			o q



2 4

	
1.	/ " "
2.	/
3.	
-	R S T
-	U V W
-	+ -
4.	15
5.	
	
1.	
2.	
3.	40
4.	1. 2

2.4.1

	10cm	5cm	6
	0 +55 , +45 55° C, (0.5% / 1) 0	-40 +70	-40 +70
	70 106 kPa 0.7 1.05	70 106 kPa 0.7 1.05	60 106 kPa 0.6 1.05
	1mm(5-13.2Hz) 7m/s ² (13.2-100Hz)	1mm(5-13.2Hz) 7m/s ² (13.2-100Hz)	3.5mm(2-9Hz) 10m/s ² (9-200Hz) 15m/s ² (200-500Hz)
		100m/s ² 11ms	100m/s ² 11ms
		250mm <100kg 100mm 100kg	250mm <100kg 100mm 100kg
	95%RH		
	1000	1000	100 1%
			3000
	2		
		/ /	6 4
	()	55	
		10	
	MPa	0.6	
	(kPa)	80-250	
	(mm)	: ø16 ø13; ø12 ø9	
		PA Teflon SMC	
		T1613W T1209W	

2.4.2



	A 250mm

ñ2@ @ñ Y^ta...# Ö Ó•Ð

2.4.4

2 1
4 2

4 3

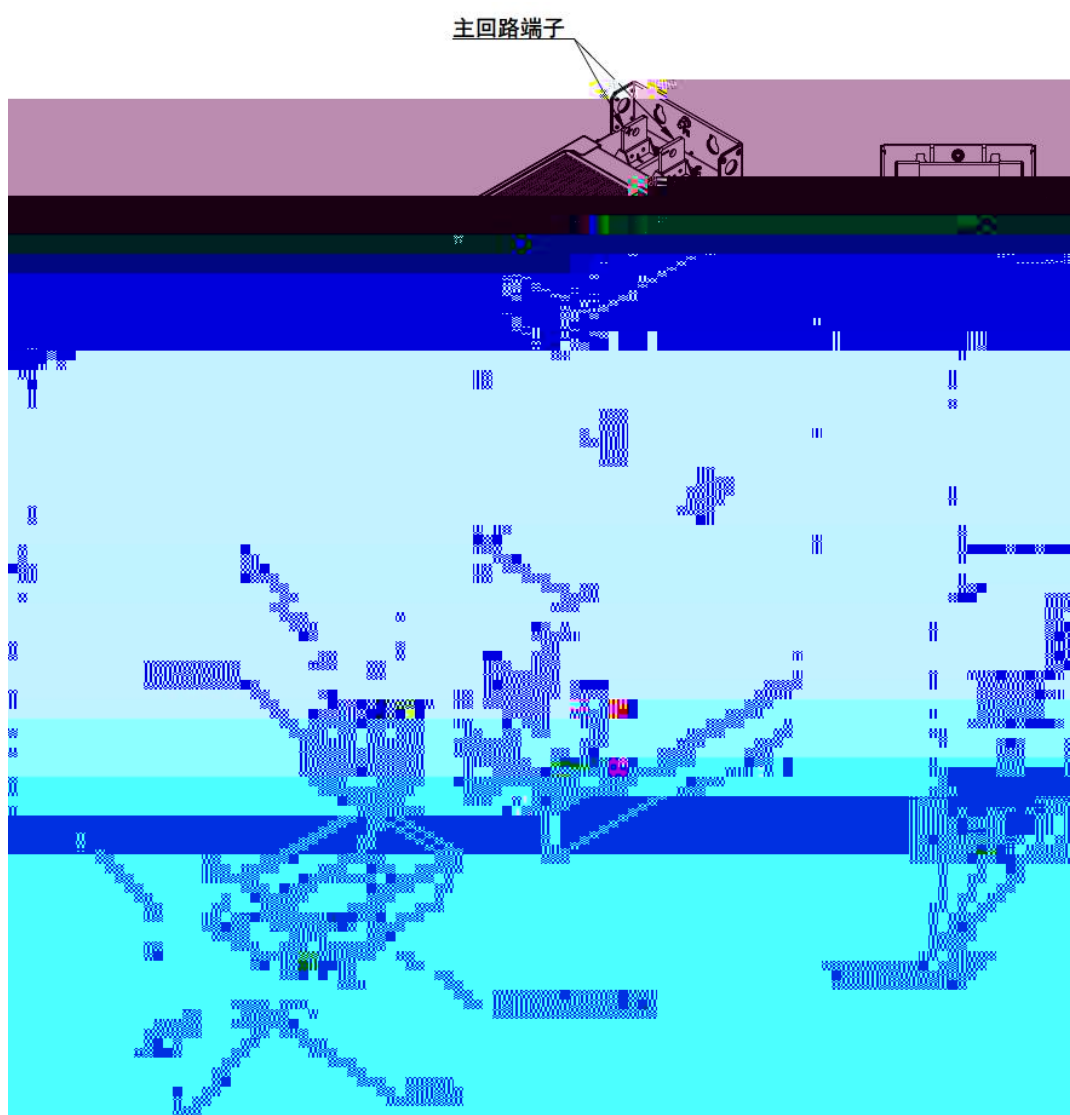

HF680NLC-560-6

1

+1 +2	
-1 -2	
R1 R2 S1 S2 T1 T2	
PE	

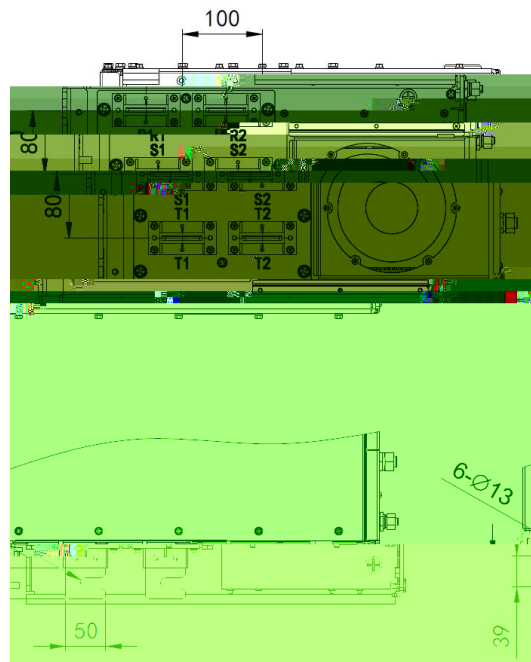
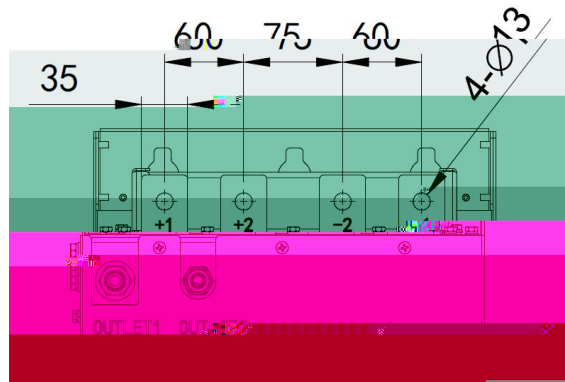

	+10V- GND	10V	+10V 50mA 1k -5k
	+24V- COM	24V	+24V 200mA
	PW		24V DI 1-DI 5 DO1 PW 24V
	AI 1- GND	1	DC -10V~10V 100k
	AI 2- GND	2	J1 -10VDC~10VDC/0mA~20mA 100k 500
	DI 1- PW	1	J2 0V~10V 0mA~20mA 3.3k 9V~30V DI 1-DI 4 500Hz DI 5 20KHz
	DI 2- PW	2	
	DI 3- PW	3	
	DI 4- PW	4	
	DI 5- PW	5	
	AO1- GND	1	J2 0V~10V 0mA~20mA
	DO1- PW	1	0V~24V 0mA~50mA
	DO4A- DO4C	1	250VAC 3A 30VDC 1A
	DO4B- DO4C	2	
	DO5A- DO5C	3	

	J2	AO1	
	J1	AI 2	

3

OV

NPN



3.3

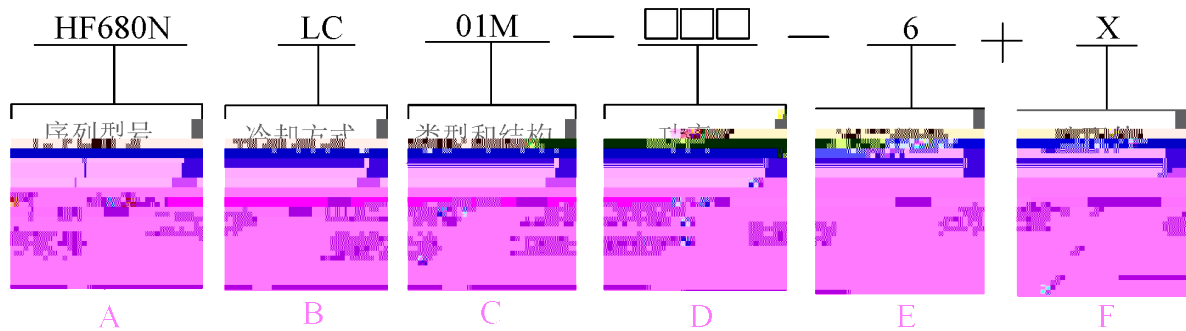

A	
B	LC
C	01M
D	1233 1233kW 1935 1935kW
E	6 690V
F	

Modbus RTU	MB01	GDHF-AMBX1	Modbus RTU
DP	DPO1	GDHF-ADPX1	Profibus DP
PN	PN01	GDHF-APNX1	Profinet
CAN	CAN01	GDHF-ACNX1	CANopen

1 HF680NLC01M1233-6+PN01 690V/1233kW

Profinet

	A AC	A DC	kVA	A DC	A DC	
HF680NLC01M1233-6	1143	1400	1370	1344	1120	P1
HF680NLC01M1935-6	1796	2200	2150	2112	1760	

1935kW

	(kW)	(l)	(l/m ² n)
HF680NLC01M1233-6	8.22	2.2	21
HF680NLC01M1935-6	12.9	2.2	26

1

2

LCD

LCD



1

+	
-	
U V W	
PE	

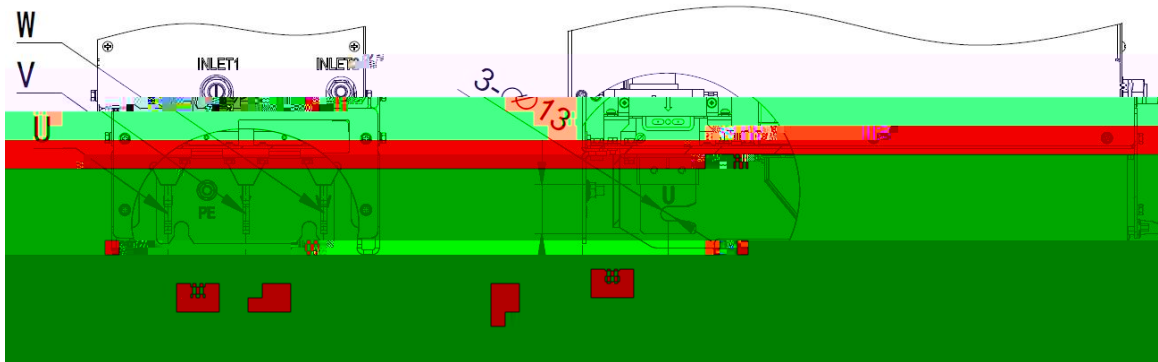
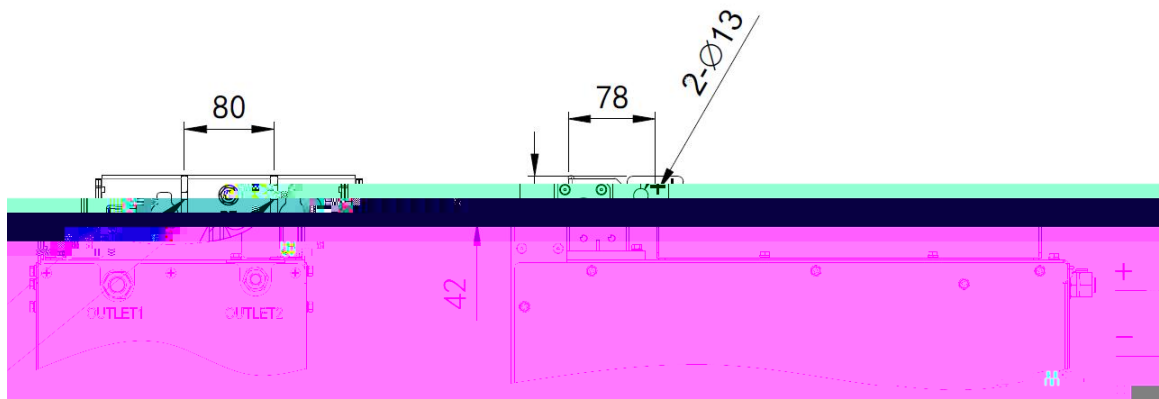

3

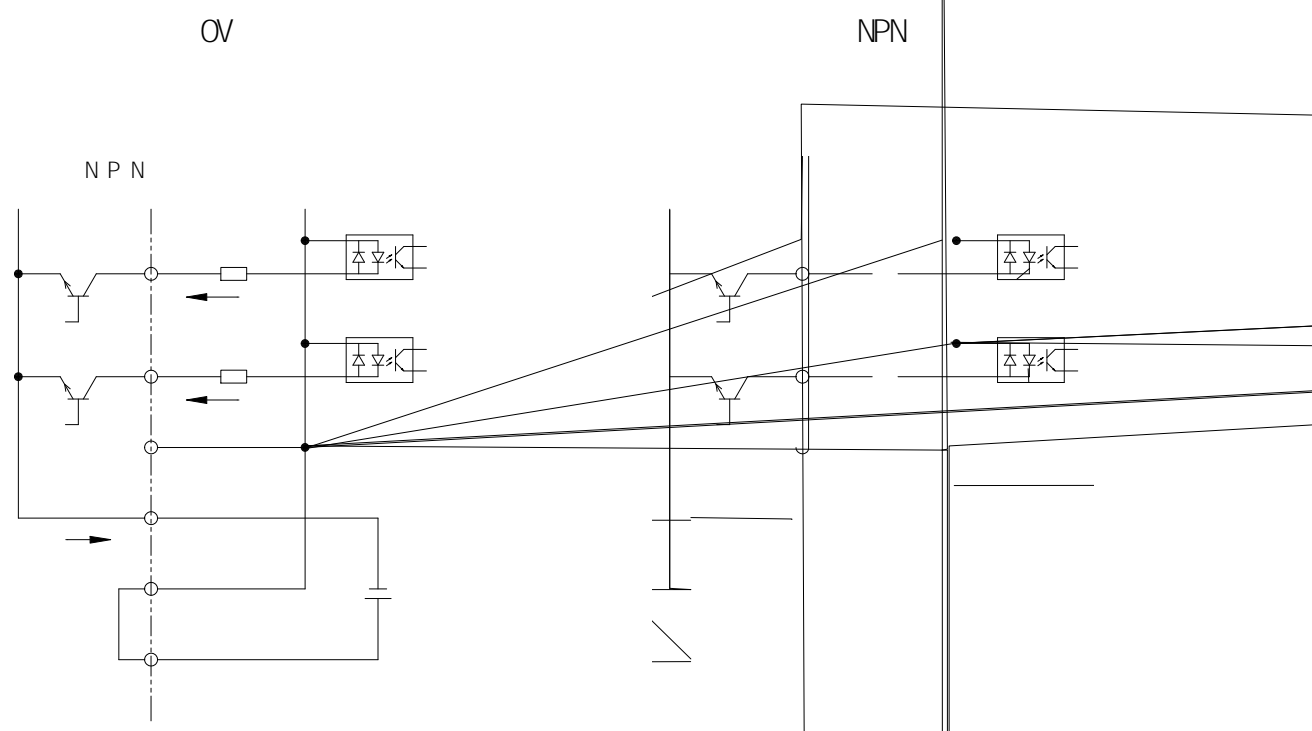

4.3

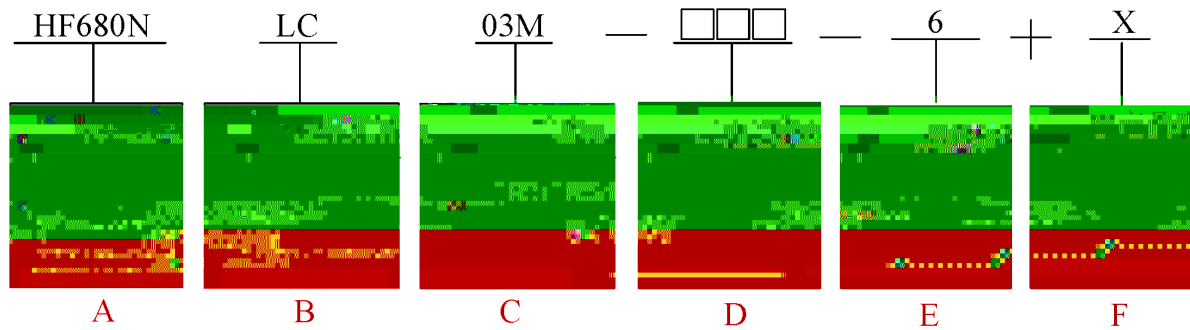

A	HF680N
B	LC
C	O3M O3C
D	160 160kW 1250 1250kW
E	6 690V
F	

Mdbus RTU	MBO1	GDHF-ANBX1	Mdbus RTU
DP	DPO1	GDHF-ADPX1	Profibus DP
PN	PNO1	GDHF-APNX1	Profinet
CAN	CANO1	GDHF-ACNX1	CANopen

HF680NLCO3M 250- 6+PNO1 690V/250kW

Profinet



HF680NLC03M 560- 6	6. 4856	1. 6	20
HF680NLC03M 630- 6	7. 285	1. 6	23
HF680NLC03C- 710- 6	8. 134	1. 6	24
HF680NLC03C- 800- 6	9. 215	1. 6	24
HF680NLC03C- 900- 6	10. 511	1. 6	24

4. 4

HF680NLC03M 160- 6	OCL - 200/ 250- 6
HF680NLC03M 200- 6	OCL - 200/ 250- 6
HF680NLC03M 250- 6	OCL - 200/ 250- 6
HF680NLC03M 280- 6	OCL - 315/ 355- 6
HF680NLC03M 315- 6	OCL - 315/ 355- 6
HF680NLC03M 355- 6	OCL - 315/ 355- 6
HF680NLC03M 400- 6	OCL - 400/ 450- 6
HF680NLC03M 450- 6	OCL - 400/ 450- 6
HF680NLC03M 500- 6	OCL - 500/ 560- 6
HF680NLC03M 560- 6	OCL - 500/ 560- 6
HF680NLC03M 630- 6	OCL - 630/ 710- 6
HF680NLC03C- 710- 6	OCL - 630/ 710- 6
HF680NLC03C- 800- 6	OCL - 800/ 900- 6
HF680NLC03C- 900- 6	OCL - 800/ 900- 6

- 1 200%
- 2 50% HF680NLC03M
- 3 HF680NLC03M

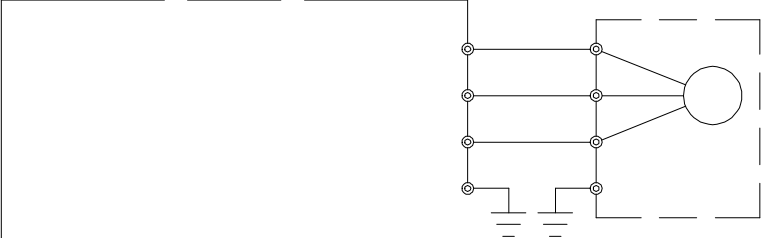

4.5

800V 1150V

24V

(V

5.

5.1



	mm					mm			8.8	kg
	H1	W1	V2	D1	D2	A	B			
HF680NLC01M1233-6	110 0	320	307	525	500	1064	200	6- 13	6-M2	260
HF680NLC01M1935-6										

5. 2

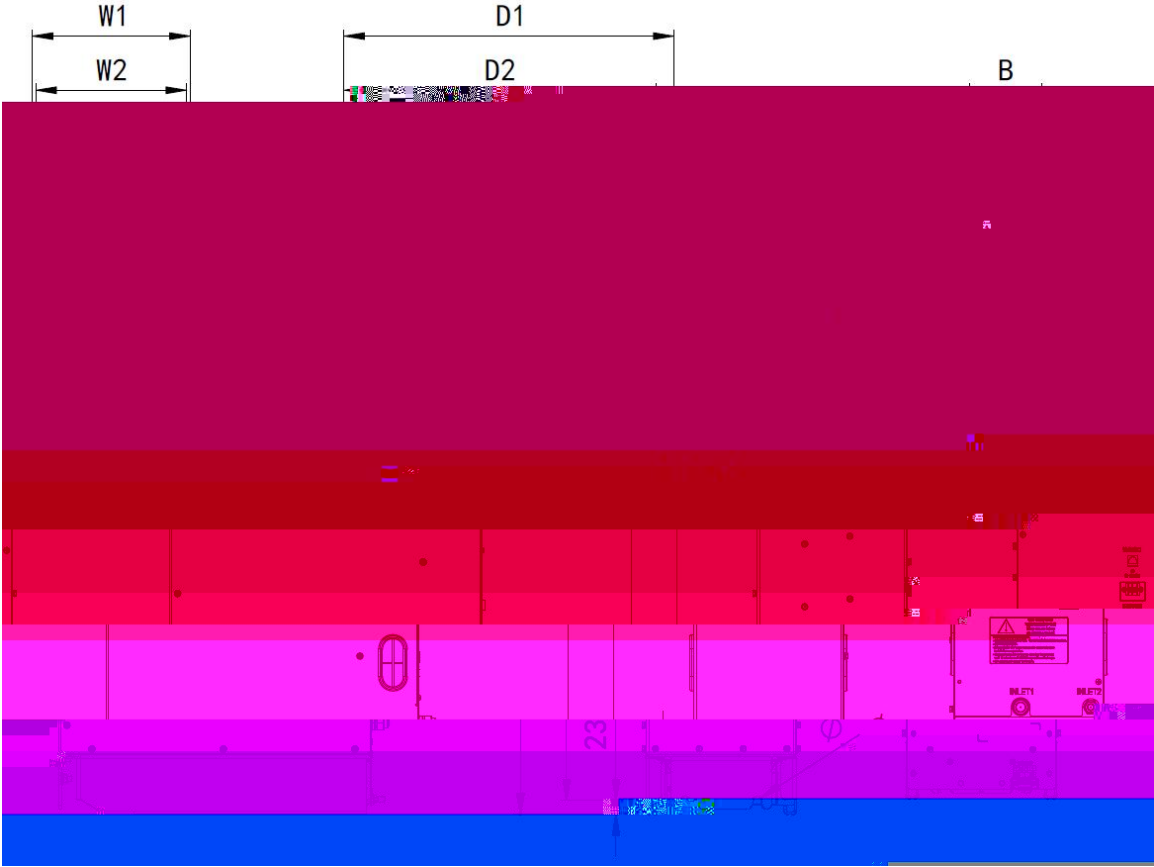

H1 mm mm 8.8 kg



6.

6.1 LCD

HF680NLC

F1

LOCAL/REMOTE

F2

RUN

STOP

/RESET

ENTER

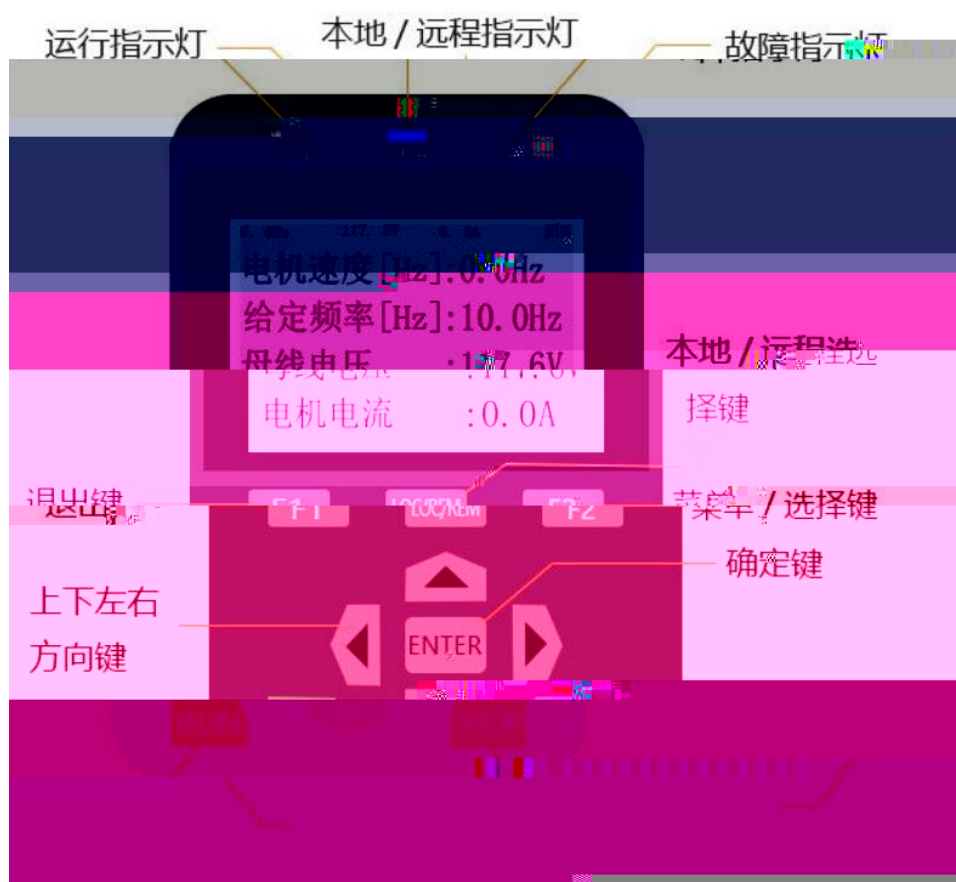

6.1.1 LCD

ENTER

RUN STOP

LOCAL/REMOTE /

LCD

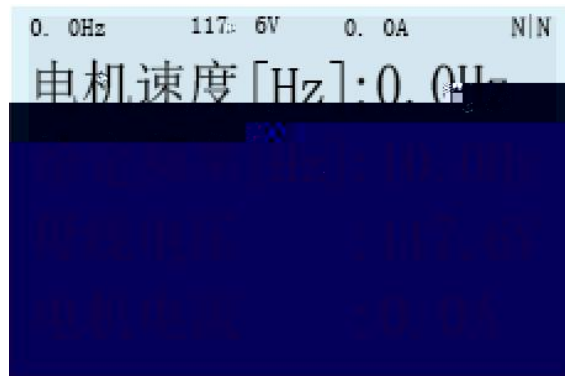

" " " " 2

	" - "
	: V
	A
	N N W E

4

ENTER

F1/F2

6.1.2 LCD

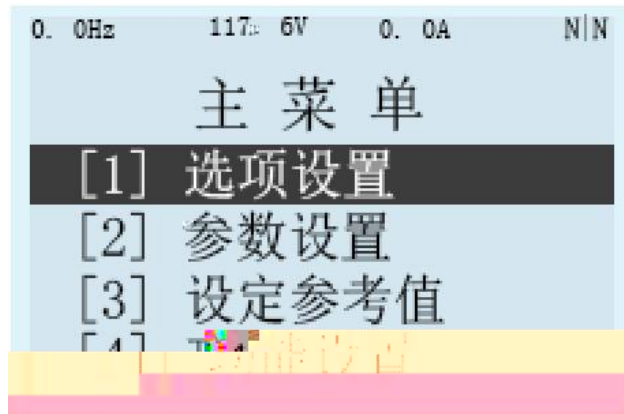

1	Option Set	
2	Parameter Setting	/
3	Reference Set	
4	Function Setting	
5	Fault Record	
6	Security	

6.1.3 LCD

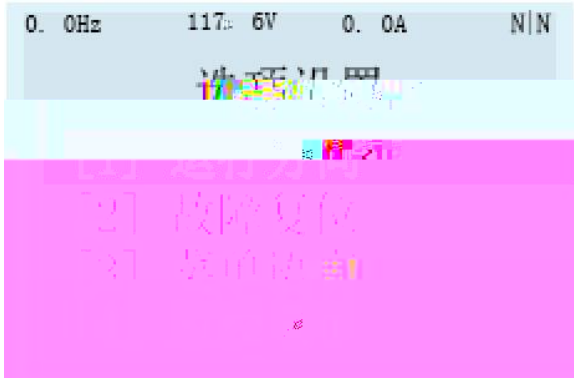

1	Choose Direction	
2	Reset Error	
3	Menu Language	
4	Monitor Setting	
5	LCD Contrast	
6	Time Setting	
7	Version	
8	OLD COM	

1 LCD

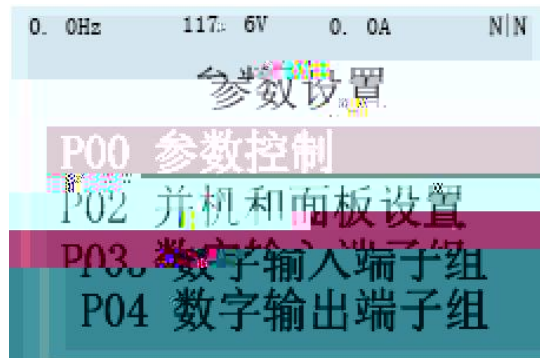

Parameter Setting

2 LCD



Reference Set

Reference Set	Speed	[Hz]	Hz
		[%]	%
	Torque	[%]	%
	Torque Limiter	[%]	%
	1	[%]	1
	2	[%]	2

3 LCD

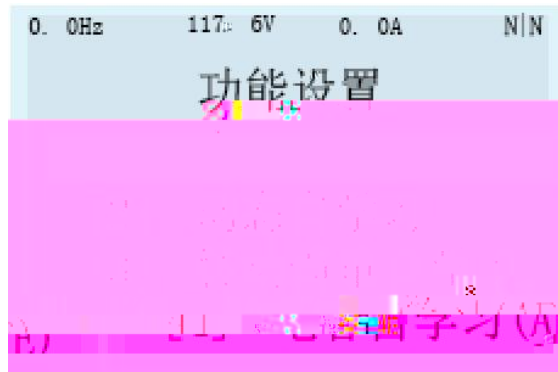

Function Setting

1	Motor Tuning I	
2	Motor Tuning II	
3	Motor Tuning III	
4	DC-Link Tuning (AFE)	AFE
5	Shortcut Paras Setting	
6	Parameter Initialization	
7	Delete Fault Records	
8	System Restart	
9	Backup Parameter	

10	Recover Parameter	
11	Compare Parameter	
12	Backup Para DSP DSP	DSP
13	Restore Para DSP DSP	DSP

1

2

5

" Enter "

4 LCD

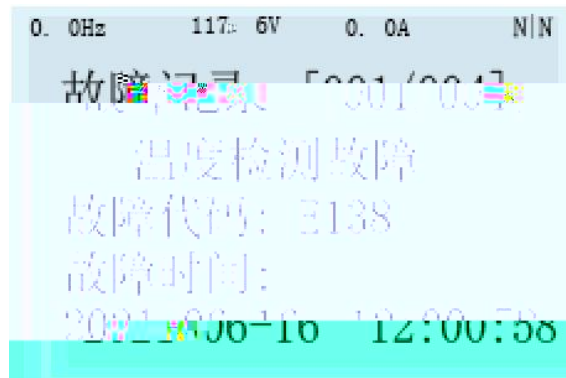

Fault Record

5 LCD

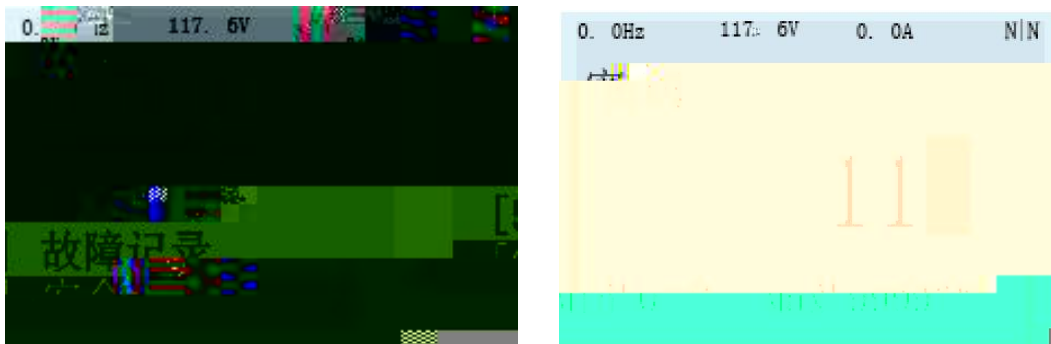

1. Access Permissions

" ENTER" " " " " " [12]

"

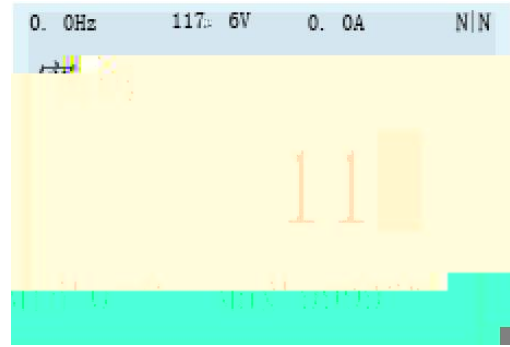
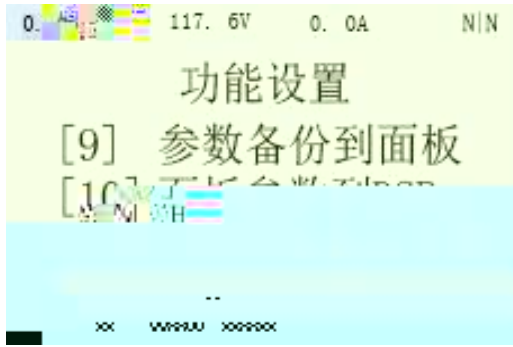

2. " " " ENTER"
 " ENTER" "

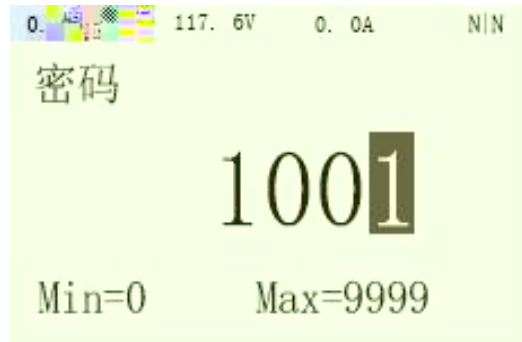
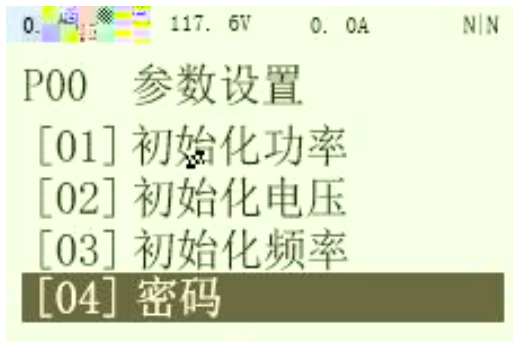

3. " " " P00 " " [04] "
 " ENTER"

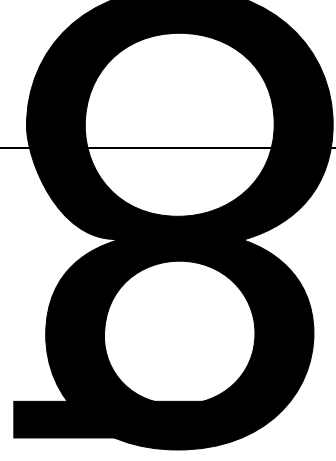
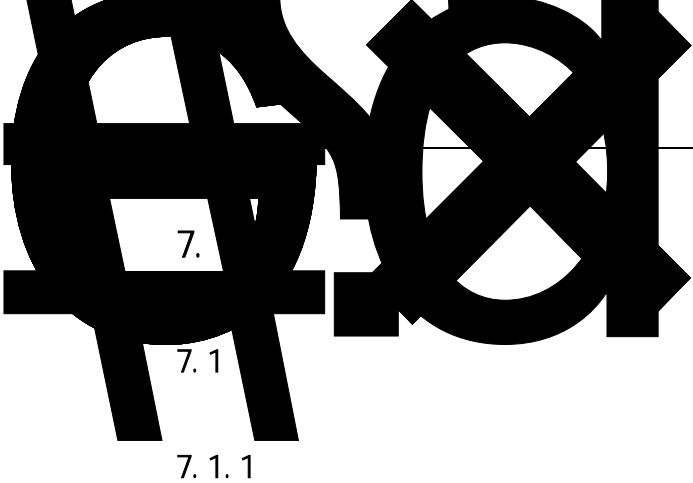

DI 1

DI 2

DI 4

D02

A¹/₄

D04

D0

D05

1

~~63~~ 63

690V

220V

PO. 1 ò

PO. 1 F9

F

!•
1\

.

" D04A" " D04C" È

" D05A" A/D05C4 È f

uA¹/₄

ex

D02 F

ê

P4.3 D04 0

P16. 0	690V		
P16. 2		1233kW	1233kW
P16. 4		1233kW	1143A
P16. 11	3		
P24. 7	OV		ADJ

690V

运行

" / " " "

103. 23

2s

103. 31

AFE

49-51Hz

103. 30

AFE

103. 23

970V

102. 54

102. 55

102. 56

停止

+ -

+ -

" / " " "

PLC

7.2



/

V/F P16. 11=0 V/F

P16. 11=2 P16. 11=1

7.3

7.3.1

1			± 5V
2		U, V, W	
3			
4	PG	PG	

7.3.2

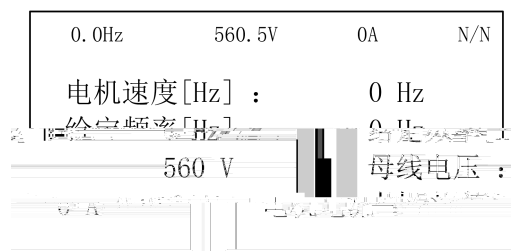

7. 3. 3

6

7. 3. 4

	[0]		
	[1]		
P8. 0	[2] DP		1
	[3] MODBUS		
	[4]		
P8. 3	[0]		1
	[1]		
P8. 6	0 300s		0
P8. 7		0 300s	0
	[0] I/O		
	[1]	1	
	[2] MODBUS	2	
P8. 10	[3]		

P16. 0		690V
P16. 2		
P16. 3		
P16. 4		
P16. 5		
P16. 6		
P16. 7		(120× P16. 5 / P16. 6)
P16. 9		(120× P16. 5 / P16. 7)
P16. 11		[0] V/F [1] [2]

7. 3. 5

1

P16. 11 [1] [2]
[0] V/F

2

V/F (P20. 74)
P20. 74

P20. 78 P20. 79 P20. 84

"

"

"

"

3

P20. 79 P20. 84

P20. 85-P20. 97

4

"

"

"

"

P20. 98

P20. 98

50%

7. 3. 6

HF680NLC

	7. 5%
	50%
	50%
	1/5
	P16
	V/F

ALL



8.

8.1

8.1.1

P2.0		[0]	0	0	
P2.2		[0] [1]	0 1	0	

8.1.2

b5

0

1

5

14

</RST

8.1.4

8.1.5

P8.0		[0] [1] [2] DP [3] MODBUS [4]	0 4	0	
P8.6			0.00 300.00 [s]	0.00 [s]	IGBT

8.1.6

P16.0			560 760 [V]	690 [V]	
P16.2			0.0 4000.0 [kW]	[kW]	
P16.4			0.0 6500.0 [A]	[A]	
P16.11		[0] V/F [1] [2] [3] [4]	0 4	0	[3]
P16.12			3 8 [kHz]	3 [kHz]	3 8kHz

8.2

8.2.1

P2

P2.0		[0] [1] [2]	0 2	0	8.1
P2.1		[0] [1] DP	0 1	0	
P2.2		[0] [1]	0 1	0	
P2.3			0 5	1	

8.2.2

P3

P3.0	1		0 32	1	
P3.1	2		0 32	2	
P3.2	3		0 32	5	
P3.3	4		0 32	6	
P3.4	5		0 32	7	
P3.5	6		0 32	8	
P3.6	7		0 32	0	
P3.7	8		0 32	0	
P3.12		[0] [1]	0 1	0	

0

7

8.2.3

P4

16		FUNC 16			
17		0		1	
18		1		2	
19		2		3	
20		3		4	
21		FUNC 21			
22					
23					
24	31	FUNC 24	FUNC 31		
	32				
33	48	FUNC 33	FUNC 48		
49		PROFI BUS	1	PROFI BUS	1
50		PROFI BUS	2	PROFI BUS	2
51		PROFI BUS	3	PROFI BUS	3
52		PROFI BUS	4	PROFI BUS	4
53		PROFI BUS	5	PROFI BUS	5
54	56	FUNC 54	FUNC 56		
57			1		
58			2		
59			3		
60			4		
61			1		1
62			2		2

8.2.4

P5

P5.0	AI 1	[0] [1] 0 +10V [2] -10 +10V [3] 0 20mA	0	3	1	
		AI 1				
P5.1	AI 1		0.0	1000.0	25.0	
			[ms]		[ms]	
P5.2	AI 1	AI 1	-10.00	10.00	0.000	9.4
			[V]		[V]	
P5.3	AI 1	AI 1	-20.00	20.00	0.000	
			[mA]		[mA]	

P5.19 AI 2

P6. 21	AO2	AO2 (P6. 14 [13])	0. 0 100. 0 [%]	0. 0 [%]	
P6. 22	AO2	AO1	0. 0 1000. 0 [ms]	10. 0 [ms]	

7-1

0

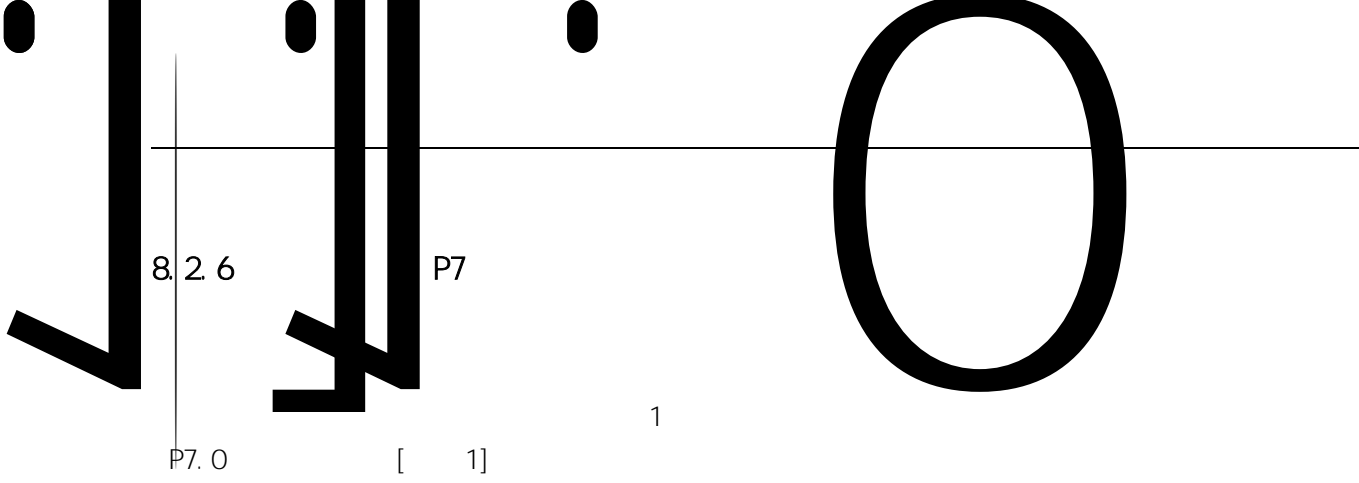

P7. 21	[3]	3	100.0 720.0 [%]	120.0 [%]	9.6
P7. 22	[4]	4	100.0 720.0 [%]	120.0 [%]	9.6
P7. 23	1 M	1	0.00 3.00 [s]	0.50 [s]	9.6
P7. 24	1 M2	2	0.00 3.00 [s]	0.50 [s]	9.6
P7. 25	1 M3	3	0.00 3.00 [s]	0.50 [s]	9.6
P7. 26	1 M4	4	0.00 3.00 [s]	0.50 [s]	9.6
P7. 27	1	1	0.00 3.00 [s]	2.00 [s]	
P7. 28	2	2	0.00 3.00 [s]	2.00 [s]	
P7. 29	3	3	0.00 3.00 [s]	2.00 [s]	
P7. 30	4	4	0.00 3.00 [s]	2.00 [s]	
P7. 31			0.0 100.0 [%]	25.0 [%]	
P7. 32			0.00 5.00 [s]	1 [s]	
P7. 33			0.0 1000.0 [s]	360.0 [s]	
P7. 47			0.0 300.0 [%]	100.0 [%]	9.6
P7. 48	1	1	0.0 300.0 [%]	150.0 [%]	9.6
P7. 49	1	1	0.00 60.00 [s]	60.00 [s]	9.6
P7. 50	2	2	0.0 300.0 [%]	200.0 [%]	9.6
P7. 51	2	2	0.00 5.00 [s]	5.00 [s]	9.6
P7. 55		[0] [1]	0 1	0	
P7. 56			0.0 200.0 [%]	120.0 [%]	
P7. 57			0.0 12.0 [s]	5 [s]	

P7. 59		[0] [1]		0 1	1	
P7. 60				0.10 3.00 [s]	0.30 [s]	
P7. 69		[0] [1]		0 1	0	9.6
P7. 70				-25 100 [V]	0 [V]	9.6
P7. 71	1	[0] [1]	5	0 1	0	9.6
P7. 73						

0

0

8.2.7

1

P8

P8.0

[0]

[1]

[2] DP

[3] MODBUS

[4]

0 4

0

P8.1

8J J

P8. 17	2		0.0 300.0 [%]	200.0 [%]	8.7
P8. 18	2	P8. 15 P8. 17	0.0 300.0 [s]	4.00 [s]	8.7
P8. 19	3		0.0 300.0 [%]	240.0 [%]	8.7
P8. 20	3	P8. 17 P8. 19	0.0 300.0 [s]	7.00 [s]	9.7
P8. 21	4		0.0 300.0 [%]	300.0 [%]	9.7
P8. 22	4	P8. 19 P8. 21	0.0 300.0 [s]	10.00 [s]	9.7
P8. 23	5		0.0 300.0 [%]	300.0 [%]	9.7
P8. 24	5	P8. 21 P8. 23	0.0 300.0 [s]	10.00 [s]	9.7
P8. 25	6		0.0 300.0 [%]	300.0 [%]	9.7
P8. 26	6	P8. 23 P8. 25	0.0 300.0 [s]	10.00 [s]	9.7
P8. 27	7		0.0 300.0 [%]	300.0 [%]	9.7
P8. 28	7	P8. 25 P8. 27	0.0 300.0 [s]	10.00 [s]	9.7
P8. 29	8		0.0 300.0 [%]	300.0 [%]	9.7
P8. 30	8	P8. 27 P8. 29	0.0 300.0 [s]	10.00 [s]	9.7
P8. 32		[0] [1] PROFIBUS [2] MODBUS [3]	0 3	0	9.7
P8. 33			0.1 10.0	1.0	9.7
P8. 34	1		0.0 300.0 [%]	100.0 [%]	9.7
P8. 35	1	P8. 34	0.0 300.0 [s]	3.00 [s]	9.7

8.2.8

2

P9

P9.0		[0] [1] [2] DP [3] MODBUS [4]	0 4	0	
P9.1					
P9.2					
P9.3		[0] [1]	0 1	0	9.7
P9.6			0.00 300.00 [s]	0.00 [s]	9.7
P9.7			0.00 300.00 [s]	0.00 [s]	9.7
P9.10		[0] I/O [1] 1 [2] 2 [3] [4] DP [5] MODBUS [6]	0 6	0	
P9.11					
P9.13		[0] [1] PROFIBUS [2] MODBUS [3]	0 3	0	9.7
P9.14			0.1 10.0	1.0	9.7
P9.15	1		0.0 300.0 [%]	100.0 [%]	9.7
P9.16	1	P9.15	0.0 300.0 [s]	3.00 [s]	9.7
P9.17	2		0.0 300.0 [%]	200.0 [%]	9.7

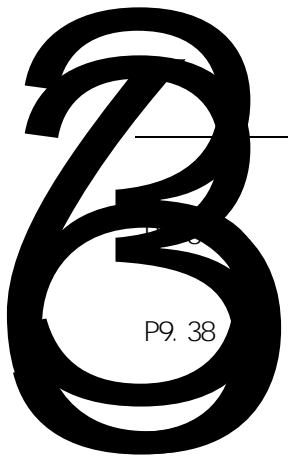

	P9. 34	P9. 36	0. 0	300. 0	4. 00	9. 7
2			[s]		[s]	

P9. 38 3



næ † ð

[æ] g 00w [s] w o

GUIDE

com

8.2.9

3

P10

P10. 18	2	P10. 15	P10. 17	0.0 300.0 [s]	4.00 [s]	9.7
P10. 19	3			0.0 300.0 [%]	240.0 [%]	9.7
P10. 20	3	P10. 17	P10. 19	0.0 300.0 [s]	7.00 [s]	9.7
P10. 21	4			0.0 300.0 [%]	300.0 [%]	9.7
P10. 22	4	P10. 19	P10. 21	0.0 300.0 [s]	10.00 [s]	9.7
P10. 23	5			0.0 300.0 [%]	300.0 [%]	9.7
P10. 24	5	P10. 21	P10. 23	0.0 300.0 [s]	10.00 [s]	9.7
P10. 25	6			0.0 300.0 [%]	300.0 [%]	9.7
P10. 26	6	P10. 23	P10. 25	0.0 300.0 [s]	10.00 [s]	9.7
P10. 27	7			0.0 300.0 [%]	300.0 [%]	9.7
P10. 28	7	P10. 25	P10. 27	0.0 300.0 [s]	10.00 [s]	9.7
P10. 29	8			0.0 300.0 [%]	300.0 [%]	9.7
P10. 30	8	P10. 27	P10. 29	0.0 300.0 [s]	10.00 [s]	9.7
P10. 32		[0] [1] PROFIBUS [2] MODBUS [3]		0 3	0	9.7
P10. 33				0.1 10.0	1.0	9.7
P10. 34	1			0.0 300.0 [%]	100.0 [%]	9.7
P10. 35	1	P10. 34		0.0 300.0 [s]	3.00 [s]	9.7
P10. 36	2			0.0 300.0 [%]	200.0 [%]	9.7

P10. 37	2	P10. 34	P10. 36	0.0	300.0	4.00	9.7
				[s]		[s]	
P10. 38	3			0.0	300.0	240.0	9.7
				[%]		[%]	
P10. 39	3	P10. 36	P10. 38	0.0	300.0	7.00	9.7
				[s]		[s]	
P10. 40	4			0.0	300.0	300.0	9.7
				[%]		[%]	
P10. 41	4	P10. 38	P10. 40	0.0	300.0	10.00	9.7
				[s]		[s]	
P10. 42	5			0.0	300.0	300.0	9.7
				[%]		[%]	
P10. 43	5	P10. 40	P10. 42	0.0	300.0	10.00	9.7
				[s]		[s]	
P10. 44	6			0.0	300.0	300.0	9.7
				[%]		[%]	
P10. 45	6	P10. 42	P10. 44	0.0	300.0	10.00	9.7
				[s]		[s]	
P10. 46	7			0.0	300.0	300.0	9.7
				[%]		[%]	
P10. 47	7	P10. 44	P10. 46	0.0	300.0	10.00	9.7
				[s]		[s]	
P10. 48	8			0.0	300.0	300.0	9.7
				[%]		[%]	
P10. 49	8	P10. 46	P10. 48	0.0	300.0	10.00	9.7
				[s]		[s]	
P10. 54				0.0	300.0	0.0	
				[%]		[%]	
P10. 55		[0]		0	1	0	
		[1]					
P10. 56				0.00	300.00	3.00	
				[s]		[s]	
P10. 57		[0]		0	1	1	
		[1]					
P10. ; v							

8.2.10	4	P11				
P11.0		[0] [1] [2] DP [3] MODBUS [4]		0 4	0	
P11.1						
P11.2						
P11.3		[0] [1]		0 1	0	9.7
P11.6				0.00 300.00 [s]	0.00 [s]	9.7
P11.7				0.00 300.00 [s]	0.00 [s]	9.7
P11.10		[0] I/O [1] 1 [2] 2 [3] [4] DP [5] MODBUS [6]		0 6	0	
P11.11						
P11.13		[0] [1] PROFIBUS [2] MODBUS [3]		0 3	0	9.7
P11.14				0.1 10.0	1.0	9.7
P11.15	1			0.0 300.0 [%]	100.0 [%]	9.7
P11.16	1		P11.15	0.0 300.0 [s]	3/	

P11. 18	2	P11. 15	P11. 17	0.0 300.0 [s]	4.00 [s]	9.7
P11. 19	3			0.0 300.0 [%]	240.0 [%]	9.7
P11. 20	3	P11. 17	P11. 19	0.0 300.0 [s]	7.00 [s]	9.7
P11. 21	4			0.0 300.0 [%]	300.0 [%]	9.7
P11. 22	4	P11. 19	P11. 21	0.0 300.0 [s]	10.00 [s]	9.7
P11. 23	5			0.0 300.0 [%]	300.0 [%]	9.7
P11. 24	5	P11. 21	P11. 23	0.0 300.0 [s]	10.00 [s]	9.7
P11. 25	6			0.0 300.0 [%]	300.0 [%]	9.7
P11. 26	6	P11. 23	P11. 25	0.0 300.0 [s]	10.00 [s]	9.7
P11. 27	7			0.0 300.0 [%]	300.0 [%]	9.7
P11. 28	7	P11. 25	P11. 27	0.0 300.0 [s]	10.00 [s]	9.7
P11. 29	8			0.0 300.0 [%]	300.0 [%]	9.7
P11. 30	8	P11. 27	P11. 29	0.0 300.0 [s]	10.00 [s]	9.7
P11. 32		[0] [1] PROFIBUS [2] MODBUS [3]		0 3	0	9.7
P11. 33				0.1 10.0	1.0	9.7
P11. 34	1			0.0 300.0 [%]	100.0 [%]	9.7
P11. 35	1	P11. 34		0.0 300.0 [s]	3.00 [s]	9.7
P11. 36	2			0.0 300.0 [%]	200.0 [%]	9.7

P11. 37	2	P11. 34	P11. 36	0.0 300.0 [s]	4.00 [s]	9.7
P11. 38	3			0.0 300.0 [%]	240.0 [%]	9.7
P11. 39	3	P11. 36	P11. 38	0.0 300.0 [s]	7.00 [s]	9.7
P11. 40	4			0.0 300.0 [%]	300.0 [%]	9.7
P11. 41	4	P11. 38	P11. 40	0.0 300.0 [s]	10.00 [s]	9.7
P11. 42	5			0.0 300.0 [%]	300.0 [%]	9.7
P11. 43	5	P11. 40	P11. 42	0.0 300.0 [s]	10.00 [s]	9.7
P11. 44	6			0.0 300.0 [%]	300.0 [%]	9.7
P11. 45	6	P11. 42	P11. 44	0.0 300.0 [s]	10.00 [s]	9.7
P11. 46	7			0.0 300.0 [%]	300.0 [%]	9.7
P11. 47	7	P11. 44	P11. 46	0.0 300.0 [s]	10.00 [s]	9.7
P11. 48	8			0.0 300.0 [%]	300.0 [%]	9.7
P11. 49	8	P11. 46	P11. 48	0.0 300.0 [s]	10.00 [s]	9.7
P11. 54				0.0 300.0 [%]	0.0 [%]	
P11. 55		[0] [1]		0 1	0	
P11. 56				0.00 300.00 [s]	3.00 [s]	
P11. 57		[0] [1]		0 1	1	
P11. 58				0.00 300.00 [s]	1.50 [s]	

8.2.11

1

P12

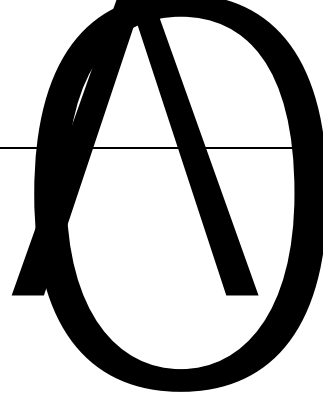

P12.0		[0]		0	1	1	9.8
		[1]					
P12.1		[0] [%]		0	2	1	
		[1] [Hz]					
		[2] [rpm]					
P12.2	1			0.0	3000.0	10.0	
P12.3	2			0.0	3000.0	20.0	
P12.4	3			0.0	3000.0	35.0	
P12.5	4			0.0	3000.0	50.0	
P12.6	5			0.0	3000.0	50.0	
P12.7	6			0.0	3000.0	50.0	
P12.8	7			0.0	3000.0	50.0	
P12.9	8			0.0	3000.0	50.0	
P12.10	9			0.0	3000.0	50.0	
P12.11	10			0.0	3000.0	50.0	
P12.12	11			0.0	3000.0	50.0	

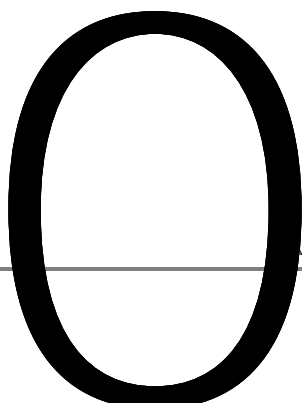

P12. 27			0.00 2.00 [s]	0.00 [s]	9.8
P12. 28			0.00 2.00 [s]	0.07 [s]	9.8
P12. 29			0.00 2.00 [s]	0.07 [s]	9.8
P12. 32			0.0 20.0 [%]	0.0 [%]	9.8
P12. 33			0.0 20.0 [%]	0.0 [%]	9.8
P12. 34			0.00 2.00 [s]	0.00 [s]	9.8
P12. 35			0.00 2.00 [s]	0.00 [s]	9.8
P12. 36			0.00 2.00 [s]	0.50 [s]	9.8
P12. 37			0.00 2.00 [s]	0.50 [s]	9.8

8.2.12 2 P13

P13.0		[0]	0	1	1	9.8
		[1]				
P13.1		[0] [%]	0	2	1	
		[1] [Hz]				
		[2] [rpm]				
P13.2	1		0.0	3000.0	10.0	
P13.3	2		0.0	3000.0	20.0	
P13.4	3		0.0	3000.0	35.0	
P13.5	4		0.0	3000.0	50.0	
P13.6	5		0.0	3000.0	50.0	
P13.7	6		0.0	3000.0	50.0	
P13.8	7		0.0	3000.0	50.0	
P13.9	8		0.0	3000.0	50.0	
P13.10	9		0.0	3000.0	50.0	
P13.11	10		0.0	3000.0	50.0	
P13.12	11		0.0	3000.0	50.0	
P13.13	12		0.0	3000.0	50.0	
P13.14	13		0.0	3000.0	50.0	
P13.15	14		0.0	3000.0	50.0	
P13.16	15		0.0	3000.0	50.0	
P13.17	16		0.0	3000.0	50.0	
P13.22			0.0	20.0	2.0	9.8
				[%]	[%]	
P13.23			0.0	20.0	0.0	9.8
				[%]	[%]	
P13.24			0.0	200.0	30.0	9.8
				[%]	[%]	
P13.25			0.0	200.0	20.0	9.8
				[%]	[%]	
P13.26			0.00	2.00	0.00	9.8
				[s]	[s]	

P13. 27			0.00 2.00 [s]	0.00 [s]	9.8
P13. 28			0.00 2.00 [s]	0.07 [s]	9.8
P13. 29			0.00 2.00 [s]	0.07 [s]	9.8
P13. 32			0.0 20.0 [%]	0.0 [%]	9.8
P13. 33			0.0 20.0 [%]	0.0 [%]	9.8
P13. 34			0.00 2.00 [s]	0.00 [s]	9.8
P13. 35			0.00 2.00 [s]	0.00 [s]	9.8
P13. 36			0.00 2.00 [s]	0.50 [s]	9.8
P13. 37			0.00 2.00 [s]	0.50 [s]	9.8

8.2.13	3	P14					
P14.0		[0]		0	1	1	9.8
		[1]					
		[0] [%]					
P14.1		[1] [Hz]		0	2	1	
		[2] [rpm]					
P14.2	1			0.0	3000.0	10.0	
P14.3	2			0.0	3000.0	20.0	
P14.4	3						

P14. 27			0.00 2.00 [s]	0.00 [s]	9.8
P14. 28			0.00 2.00 [s]	0.07 [s]	9.8
P14. 29			0.00 2.00 [s]	0.07 [s]	9.8
P14. 32			0.0 20.0 [%]	0.0 [%]	9.8
P14. 33			0.0 20.0 [%]	0.0 [%]	9.8
P14. 34			0.00 2.00 [s]	0.00 [s]	9.8
P14. 35			0.00 2.00 [s]	0.00 [s]	9.8
P14. 36			0.00 2.00 [s]	0.50 [s]	9.8
P14. 37			0.00 2.00 [s]	0.50 [s]	9.8

8.2.14

4

P15

P15. 27	00 2.00 [s]	0.00 [s]	9.8
P15. 28	00 2.00 [s]	0.07 [s]	9.8
P15. 29	0.00 2.00 [s]	0.07 [s]	9.8
P15. 32	0.0 20.0 [%]	0.0 [%]	9.8
P15. 33	0.0 20.0 [%]	0.0 [%]	9.8
P15. 34	0.00 2.00 [s]	0.00 [s]	9.8
P15. 35	0.00 2.00 [s]	0.00 [s]	9.8
P15. 36	0.00 2.00		

8.2.15 1 V/F P16

P16.19	[0]	0	1	0	
	[1]				
P16.22		0.00	100.00	0.00	9.9
		[s]		[s]	
P16.23					

P16. 47	@			0 300	0
		[0]			
P16. 48		[1] P I D	1	0 3	0
		[2] P I D	2		
		[3]			
P16. 49	@			0 300	0
P16. 50				0.00 300.00	
				[s]	

8.2.16 2 V/F P17

P17.0			560 760 [V]	690 [V]	
P17.2			0.0 3000.0 [kW]	[kW]	
P17.3			0 700 [V]	690 [V]	
P17.4			0.0 3000.0 [A]	[A]	
P17.5			0.0 300.0 [Hz]	50.0 [Hz]	
P17.6			0 6000 [rpm]	1465 [rpm]	
P17.7			2 12 [pole]	4 [pole]	9.9
P17.9			0 7200 [rpm]	1500 [rpm]	9.9
P17.11		[0] V/F [1] [2] [3] [4]	0 4	0	
P17.12			1.00 10.00 [kHz]	3.00 [kHz]	9.9
P17.14	V/F	[0] V/F [1] V/F [2]	0 3	0	9.9
P17.15		[0] [1]	0 1	0	9.9
P17.16			2 500 [ms]	500 [ms]	
P17.17	V/F	[0] [1]	0 1	0	
P17.18			10 1000 [ms]	200 [ms]	
P17.19		[0] [1]	0 1	0	

P17. 22			0. 00	100. 00	0. 00		9. 9
			[s]		[s]		
P17. 23		V/F	0. 00	300. 00	0. 00		
			[Hz]		[Hz]		
P17. 24		V/F	0. 00	300. 00	50. 00		
			[Hz]		[Hz]		
P17. 25			0. 0	120. 0	100. 0		
			[%]		[%]		
P17. 26	V/F	V/F	0. 00	10. 00	0. 75		9. 9
			[%]		[%]		
P17. 27			0. 0	200. 0	100. 0		9. 9
			[%]		[%]		
P17. 30			0. 0	100. 0	0. 0		9. 9
			[%]		[%]		
P17. 33	V/F						

P17. 48		[0] [1] P I D 1 [2] P I D 2 [3]	0 3	0	
P17. 49	@		0 300	0	
P17. 50			0.00 300.00 [s]	0.00 [s]	9.9
P17. 51			0.0 150.0 [%]	70.0 [%]	9.9
P17. 52			0.00 5.00 [Hz]	0.00 [Hz]	9.9
P17. 54			0.00 300.00 [s]	0.00 [s]	9.9
P17. 55			0.0 150.0 [%]	75.0 [%]	9.9
P17. 56			0.00 5.00 [Hz]	0.00 [Hz]	9.9
P17. 59			0.0 1000.0 [%]	100.0 [%]	
P17. 60			0.0 1000.0 [%]	100.0 [%]	
P17. 61			0.0 1000.0 [%]	100.0 [%]	
P17. 62			0.0 1000.0 [%]	100.0 [%]	
P17. 64	V/F	V/F	0.0 1000.0 [%]	100.0 [%]	9.9
P17. 66		V/F	0.0 1000.0 [%]	100.0 [%]	
P17. 67			0.0 1000.0 [%]	100.0 [%]	
P17. 68			0.0 1000.0 [%]	100.0 [%]	
P17. 69			0.0 1000.0 [%]	100.0 [%]	
P17. 70			0.0 1000.0 [%]	100.0 [%]	



P18. 22			0. 00 100. 00	0. 00	
			[s]	[s]	8. 9
P18. 23			0. 00 300. 00	0. 00	
	V/F		[Hz]	[Hz]	
P18. 24			0. 00 00. 00		
	V/F		[Hz]	[Hz]	
P18. 25			0. 0 20. 0		
			[%]	[%]	
P18. 26	V/F	V/F	0. 00 0. 00	0. 75	
			[%]	[%]	9. 9
P18. 27			0. 0 00. 0	100. 0	
			[%]	[%]	9. 9
P18. 30					
	9				



8.2.18 4 V/F P19

P19.0			560 760	690	
			[V]	[V]	
P19.2			0.0 3000.0		
			[kW]	[kW]	
P19.3			0 700	690	
			[V]	[V]	
P19.4			0.0 3000.0		
			[A]	[A]	
P19.5			0.0 300.0	50.0	
			[Hz]	[Hz]	
P19.6			0 6000	1465	
			[rpm]	[rpm]	
P19.7			2 12	4	9.9
			[pole]	[pole]	
P19.9			0 7200	1500	9.9
			[rpm]	[rpm]	
		[0] V/F			
		[1]			
P19.11		[2]	0 4	0	
		[3]			
		[4]			
P19.12			1.00 10.00	3.00	9.9
			[kHz]	[kHz]	
		[0] V/F			
P19.14 V/F		[1] V/F	0 3	0	9.9
		[2]			
P19.15		[0]	0 1	0	9.9
		[1]			
P19.16					



		[0]			
P19. 48		[1] P I D	1	0 3	0
		[2] P I D	2		
		[3]			
P19. 49	@			0 300	0
P19. 50				0.00 300.00	0.00
				[s]	[s]
P19. 51				0.0 150.0	70.0
				[%]	[%]
P19. 52				0.00 5.00	0.00
				[Hz]	[Hz]
P19. 54				0.00 300.00	0.00
				[s]	[s]
P19. 55				0.0 150.0	75.0
				[%]	[%]
P19. 56				0.00 5.00	0.00
				[Hz]	[Hz]
P19. 59				0.0 1000.0	100.0
				[%]	[%]
P19. 60				0.0 1000.0	100.0
				[%]	[%]
P19. 61				0.0 1000.0	100.0
				[%]	[%]
P19. 62				0.0 1000.0	100.0
				[%]	[%]
P19. 64 V/F		V/F		0.0 1000.0	100.0
				[%]	[%]
P19. 66		V/F		0.0 1000.0	100.0
				[%]	[%]
P19. 67				0.0 1000.0	100.0
				[%]	[%]
P19. 68				0.0 1000.0	100.0
				[%]	[%]
P19. 69				0.0 1000.0	100.0
				[%]	[%]
P19. 70				0.0 1000.0	100.0
				[%]	[%]

8.2.19 1 P20

P20.0

P20.12			0.0	2000.0	100.0	9.10
			[%		[%	
P20.13			20.0	500.0	100.0	9.10
			[ms]		[ms]	
P20.14		1	0	60000	1024	
P20.15	[0]					
	[1]					

	[0]	P20. 31		
		P20. 32		
P20. 30	[1]	1	0 3	0
	[2]	2		
	[3]			
P20. 31			0.0 100.0	5.0
			[%]	[%]
P20. 32			0.0 100.0	5.0
			[%]	[%]
P20. 34	[0]		0 1	0
	[1]			9. 10
P20. 35			0.0 100.0	0.0
			[s]	[s]
P20. 36			50.0 150.0	110.0
			[%]	[%]
P20. 37			0.0 150.0	100.0
			[%]	[%]
P20. 38			0.0 100.0	25.0
			[%]	[%]
P20. 39			0.0 120.0	100.0
			[%]	[%]
P20. 40			0.0 150.0	100.0
			[%]	[%]
P20. 41			0.0 150.0	135.0
			[%]	[%]
P20. 42	[0]		0 1	1
	[1]			
P20. 43			25 1000	75
			[ms]	[ms]
P20. 44			25 1000	250
			[ms]	[ms]
P20. 45			0.0 100.0	22.0
			[%]	[%]
P20. 46			0.0 100.0	18.0
			[%]	[%]
P20. 47			0.0 200.0	92.0
			[%]	[%]
P20. 48			0.0 200.0	87.0
			[%]	[%]

P20. 49		0. 0	150. 0	100. 0	
		[%		[%	
P20. 51		0. 0	1000. 0	100. 0	
		[%		[%	
P20. 52		0. 0	1000. 0	100. 0	
		[%		[%	
P20. 53	Kp	0. 0	1000. 0	100. 0	
		[%		[%	
P20. 54	Ki	0. 0	1000. 0	100. 0	
		[%		[%	
P20. 55		0. 0	1000. 0	100. 0	9. 10
		[%		[%	
P20. 56		0. 0	1000. 0	100. 0	9. 10
		[%		[%	
P20. 57					

P20. 74				0. 00	650. 00	0. 00	
				[nChm]		[nChm]	
P20. 75				0. 70	1. 00	0. 90	
P20. 76	1		1	90. 0	110. 0	100. 0	
				[%]		[%]	
P20. 77	2		2	90. 0	110. 0	100. 0	
				[%]		[%]	
P20. 78				0. 00	650. 00	0. 00	
				[nChm]		[nChm]	
P20. 79				0. 00	65. 50	0. 000	
				[nH]		[nH]	
P20. 80	1		1	0. 800	1. 350	1. 140	
				[%]		[%]	
P20. 81	2		2	0. 800	1. 350	0. 940	
				[%]		[%]	
P20. 82	3		3	0. 800	1. 350	1. 080	
				[%]		[%]	
P20. 83	4		4	0. 800	1. 350	0. 950	
				[%]		[%]	
P20. 84				0. 00	655. 00	0. 00	
				[nChm]		[nChm]	
P20. 85	85%	85%		40. 0	150. 0	108. 0	
				[%]		[%]	
P20. 86	87. 5%	87. 5%		40. 0	150. 0	106. 5	
				[%]		[%]	
P20. 87	90%	90%		40. 0	150. 0	105. 0	
				[%]		[%]	
P20. 88	92. 5%	92. 5%		40. 0	150. 0	103. 5	
				[%]		[%]	
P20. 89	95%	95%		40. 0	150. 0	102. 0	
				[%]		[%]	
P20. 90	102. 5%	102. 5%		40. 0	150. 0	99. 0	
				[%]		[%]	
P20. 91	105%	105%		40. 0	150. 0	96. 5	
				[%]		[%]	
P20. 92	110%	110%		40. 0	150. 0	93. 0	
				[%]		[%]	

P20. 98		()	0. 01 300. 00 [s]	0. 75 [s]	
P20. 99			0. 00 10. 00 [%]	0. 00 [%]	

8. 2. 20 2 P21

P21. 0		[0]		0 1	0	9. 10
		[1]				
		[0]				
		[1]	1			
		[2]	2			
P21. 1		[3]		0 7	0	9. 10
		[4]	P21. 3			
		[5] DP				
		[6] MODBUS				
		[7]				
P21. 2				0 7	0	
P21. 3				- 300. 0 300. 0 [%]	0. 0 [%]	9. 10
P21. 4	@			0 300	0	
P21. 5				0 1000 [ms]	0 [ms]	
P21. 6				0. 0 200. 0 [%]	100. 0 [%]	9. 10
		[0]				
		[1]	N			
P21. 7						

P21. 10		0 300	0	
P21. 11		0 1000 [ms]	0 [ms]	
P21. 12		0.0 2000.0 [%]	100.0 [%]	9. 10
P21. 13		20.0 500.0 [ms]	100.0 [ms]	9. 10
P21. 14		1	0 60000	1024
P21. 15	[0] [1]		0 1	0 9. 10
P21. 16		0.0 300.0 [%]	100.0 [%]	
P21. 17		0.0 300.0 [%]	100.0 [%]	
P21. 18		0.0 300.0 [%]	0.0 [%]	
P21. 19		0.0 300.0 [%]	0.0 [%]	
P21. 20	[0] [1]		0 1	0
P21. 21	[0] [1]		0 1	0
P21. 22		0.0 300.0 [%]	160.0 [%]	
P21. 23		0.0 200.0 [%]	20.0 [%]	
P21. 24		0.0 300.0 [%]	100.0 [%]	
P21. 25		0.0 200.0 [%]	100.0 [%]	
P21. 26		0.0 1000.0 [%]	0.0 [%]	9. 10
P21. 27		0.00 15.00 [%]	2.00 [%]	9. 10
P21. 28	[0] P21. 16 P21. 17 [1] [2] [3] DP		0 3	0

P21. 30		[0] P21. 31 P21. 32 [1] 1 [2] 2 [3]	0 3	0	
P21. 31			0.0 100.0 [%]	5.0 [%]	
P21. 32			0.0 100.0 [%]	5.0 [%]	
P21. 34		[0] [1]	0 1	0	9. 10
P21. 35			0.0 100.0 [s]	0.0 [s]	
P21. 36			50.0 150.0 [%]	110.0 [%]	
P21. 37			0.0 150.0 [%]	100.0 [%]	9. 10
P21. 38			0.0 100.0 [%]	25.0 [%]	9. 10
P21. 39			0.0 120.0 [%]	100.0 [%]	9. 10
P21. 40			0.0 150.0 [%]	100.0 [%]	9. 10
P21. 41			0.0 150.0 [%]	135.0 [%]	
P21. 42		[0] [1]	0 1	1	
P21. 43			25 1000 [ms]	75 [ms]	
P21. 44			25 1000 [ms]	250 [ms]	
P21. 45			0.0 100.0 [%]	22.0 [%]	
P21. 46			0.0 100.0 [%]	18.0 [%]	
P21. 47			0.0 200.0 [%]	92.0 [%]	
P21. 48			0.0 200.0 [%]	87.0 [%]	



P21. 98		()	0. 01 300. 00 [s]	0. 75 [s]	
P21. 99			0. 00 10. 00 [%]	0. 00 [%]	

8. 2. 21 3 P22





P

P22. 49			0.0 150.0 [%]	100.0 [%]	
P22. 51			0.0 1000.0 [%]	100.0 [%]	
P22. 52			0.0 1000.0 [%]	100.0 [%]	
P22. 53	Kp		0.0 1000.0 [%]	100.0 [%]	
P22. 54	Ki		0.0 1000.0 [%]	100.0 [%]	
P22. 55			0.0 1000.0 [%]	100.0 [%]	9. 10
P22. 56			0.0 1000.0 [%]	100.0 [%]	9. 10
P22. 57		[0] [1]	0 1	0	9. 10
P22. 58			0.0 125.0 [%]	100.0 [%]	9. 10
P22. 59			1.0 25.0 [%]	2.5 [%]	9. 10
P22. 60	DROOP	0 DROOP	0.0 100.0 [%]	0.0 [%]	9. 10
P22. 61	DROOP	DROOP	30 2000 [ms]	50 [ms]	9. 10
P22. 62			0.0 1000.0 [%]	100.0 [%]	9. 10
P22. 63			0.0 1000.0 [%]	100.0 [%]	9. 10
P22. 66	1	1	0.0 1000.0 [%]	100.0 [%]	
P22. 67	2	2	0.0 1000.0 [%]	100.0 [%]	
P22. 69			0.00 2.00 [%]	1.00 [%]	
P22. 70			0.00 2.00 [%]	1.00 [%]	
P22. 71		[0] [1]	0 1	0	
P22. 72		[0] [1]	0 1	1	
P22. 73		[0] × 1 [1] × 10	0 1	0	

P22. 74			0. 00 650. 00 [nChm]	0. 00 [nChm]	
P22. 75			0. 70 1. 00	0. 90	
P22. 76	1	1	90. 0 110. 0 [%]	100. 0 [%]	
P22. 77	2	2	90. 0 110. 0 [%]	100. 0 [%]	
P22. 78			0. 00 650. 00 [nChm]	0. 00 [nChm]	
P22. 79			0. 00 65. 50 [mH]	0. 000 [mH]	
P22. 80	1	1	0. 800 1. 350	1. 140	
P22. 81	2	2	0. 800 1. 350	0. 940	
P22. 82	3	3	0. 800 1. 350	1. 080	
P22. 83	4	4	0. 800 1. 350	0. 950	
P22. 84			0. 00 655. 00 [mH]	0. 00 [mH]	
P22. 85	85%	85%	40. 0 150. 0 [%]	108. 0 [%]	
P22. 86	87. 5%	87. 5%	40. 0 150. 0 [%]	106. 5 [%]	
P22. 87	90%	90%	40. 0 150. 0 [%]	105. 0 [%]	
P22. 88	92. 5%	92. 5%	40. 0 150. 0 [%]	103. 5 [%]	
P22. 89	95%	95%	40. 0 150. 0 [%]	102. 0 [%]	
P22. 90	102. 5%	102. 5%	40. 0 150. 0 [%]	99. 0 [%]	
P22. 91	105%	105%	40. 0 150. 0 [%]	96. 5 [%]	
P22. 92	110%	110%	40. 0 150. 0 [%]	93. 0 [%]	
P22. 93	115%	115%	40. 0 150. 0 [%]	88. 5 [%]	
P22. 94	120%	120%	40. 0 150. 0 [%]	83. 0 [%]	
P22. 95	125%	125%	40. 0 150. 0 [%]	77. 0 [%]	
P22. 96	130%	130%	40. 0 150. 0 [%]	70. 5 [%]	
P22. 97	135%	135%	40. 0 150. 0 [%]	63. 5 [%]	

P22. 98

()



P23. 10	0 300	0
P23. 11	0 1000	0
	[ms]	[ms]
P23. 12	0.0 2000.0	
	[%]	



i. E09

VI25i. E09. 05 I

0 0 0

“

103-

U

E O U U U

E O

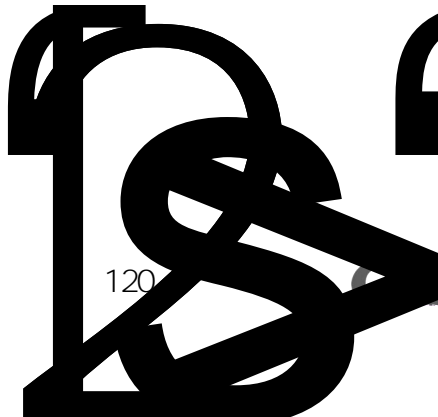

P23. 74			0. 00 650. 00	0. 00
			[nOhm]	[nOhm]
P23. 75			0. 70 1. 00	0. 90
P23. 76	1	1	90. 0 110. 0	100. 0
			[%]	[%]
P23. 77	2	2	90. 0 110. 0	100. 0
			[%]	[%]
P23. 78			0. 00 650. 00	0. 00
			[nOhm]	[nOhm]
P23. 79			0. 00 65. 50	0. 000
			[mH]	[mH]
P23. 80				

P23. 98		()	0. 01 300. 00 [s]	0. 75 [s]	
P23. 99			0. 00 10. 00 [%]	0. 00 [%]	

8. 2. 23 MODBUS P32

P32. 0	MODBUS	[0] [1]	0 1	0	
P32. 1	MODBUS I D		1 255	1	
P32. 2		[0] RS485 [1] RS232	0 1	0	
P32. 3		[0] 9600 BPS [1] 14400 BPS [2] 19200 BPS [3] 38400 BPS [4] 56000 BPS [5] 57600 BPS [6] 115200 BPS	0 6	3	
P32. 4		[0] None_8_1_CFG [1] Even_8_1_CFG [2] Odd_8_1_CFG [3] None_8_2_CFG [4] Even_8_2_CFG [5] Odd_8_2_CFG	0 5	0	
P32. 5	Modbus	Modbus 0 Modbus	0 100 [s]	0 [s]	0s
P32. 6	Modbus	0- 1-	0 1	0	

8. 2. 24

P33

P33. 18	[VØ]	[0] × 1	0 4	0
		[1] × 10		
		[2] × 100		
		[3] × 1000		
		[4] × 10000		
P33. 19	[VØ]	7-2	0 37	0
		[0] × 1		
P33. 20	[VØ]	[1] × 10	0 4	0
		[2] × 100		
		[3] × 1000		
		[4] × 10000		
		7-2		
P33. 21	[VØ]	7-2	0 37	1
		[0] × 1		
P33. 22	[VØ]	[1] × 10	0 4	0
		[2] × 100		
		[3] × 1000		
		[4] × 10000		
		7-2		
P33. 23	[VØ]	7-2	0 37	18
		[0] × 1		
P33. 24	[VØ]	[1] × 10	0 4	2
		[2] × 100		
		[3] × 1000		
		[4] × 10000		
		7-2		
P33. 25	[VØ]	7-2	0 37	21
		[0] × 1		
P33. 26	[VØ]	[1] × 10	0 4	1
		[2] × 100		
		[3] × 1000		
		[4] × 10000		
		7-2		
P33. 27	[VØ]	7-2	0 37	22
		[0] × 1		
P33. 28	[VØ]	[1] × 10	0 4	1
		[2] × 100		
		[3] × 1000		
		[4] × 10000		
		7-2		

P33. 31	[WØ]	7-2	0 37	0	
P33. 32	[WØ]	[0] × 1 [1] × 10 [2] × 100 [3] × 1000 [4] × 10000	0 4	0	
P33. 33	[W0]	7-2	0 37	0	
P33. 34	[W0]	[0] × 1 [1] × 10 [2] × 100 [3] × 1000 [4] × 10000	0 4	0	
P33. 35	[W1]	7-2	0 37	0	
P33. 36	[W1]	[0] × 1 [1] × 10 [2] × 100 [3] × 1000 [4] × 10000	0 4	0	
P33. 37	[W2]	7-2	0 37	0	
P33. 38	[W2]	[0] × 1 [1] × 10 [2] × 100 [3] × 1000 [4] × 10000	0 4	0	
P33. 39	[W3]	7-2	0 37	0	
P33. 40	[W3]	[0] × 1 [1] × 10 [2] × 100 [3] × 1000 [4] × 10000	0 4	0	
P33. 41	[W4]	7-2	0 37	0	
P33. 42	[W4]	[0] × 1 [1] × 10 [2] × 100 [3] × 1000 [4] × 10000	0 4	0	
P33. 43	[W5]	7-2	0 37	0	

P33. 44	[W5]	[0] × 1 [1] × 10 [2] × 100 [3] × 1000 [4] × 10000	0 4	0	
P33. 45	[V0]	7-3	0 48	0	
P33. 46	[V0]	[0] × 1 [1] × 10 [2] × 100 [3] × 1000 [4] × 10000 [5] [% × 1 [6] [% × 10 [7] [% × 100	0 7	0	
P33. 47	[W1]	7-3	0 48	0	
P33. 48	[W1]	[0] × 1 [1] × 10 [2] × 100 [3] × 1000 [4] × 10000 [5] [% × 1 [6] [% × 10 [7] [% × 100	0 7	0	
P33. 49	[V2]	7-3	0 48	0	
P33. 50	[V2]	[0] × 1 [1] × 10 [2] × 100 [3] × 1000 [4] × 10000 [5] [% × 1 [6] [% × 10 [7] [% × 100	0 7	0	
P33. 51	[V3]	7-3	0 48	0	
P33. 52	[V3]	[0] × 1 [1] × 10 [2] × 100 [3] × 1000 [4] × 10000 [5] [% × 1 [6] [% × 10 [7] [% × 100	0 7	0	
P33. 53	[W4]	7-3	0 48	1	

P33. 54	[W4]	[0] × 1 [1] × 10 [2] × 100 [3] × 1000 [4] × 10000 [5] [%] × 1 [6] [%] × 10 [7] [%] × 100	0 7	0	
P33. 55	[W5]	7-3	0 48	19	
P33. 56	[W5]	[0] × 1 [1] × 10 [2] × 100 [3] × 1000 [4] × 10000 [5] [%] × 1 [6] [%] × 10 [7] [%] × 100	0 7	2	
P33. 57	[W6]	7-3	0 48	26	
P33. 58	[W6]	[0] × 1 [1] × 10 [2] × 100 [3] × 1000 [4] × 10000 [5] [%] × 1 [6] [%] × 10 [7] [%] × 100	0 7	6	
P33. 59	[W7]	7-3	0 48	30	
P33. 60	[W7]	[0] × 1 [1] × 10 [2] × 100 [3] × 1000 [4] × 10000 [5] [%] × 1 [6] [%] × 10 [7] [%] × 100	0 7	1	
P33. 61	[W8]	7-3	0 48	14	

P33. 70	[W2]	[0] × 1 [1] × 10 [2] × 100 [3] × 1000 [4] × 10000 [5] [% × 1 [6] [% × 10 [7] [% × 100	0 7	0	
P33. 71	[W3]	7-3	0 48	0	
P33. 72	[W3]	[0] × 1 [1] × 10 [2] × 100 [3] × 1000 [4] × 10000 [5] [% × 1 [6] [% × 10 [7] [% × 100	0 7	0	
P33. 73	[W4]	7-3	0 48	0	
P33. 74	[W4]	[0] × 1 [1] × 10 [2] × 100 [3] × 1000 [4] × 10000 [5] [% × 1 [6] [% × 10 [7] [% × 100	0 7	0	
P33. 75	[W5]	7-3	0 48	0	
P33. 76	[W5]	[0] × 1 [1] × 10 [2] × 100 [3] × 1000 [4] × 10000 [5] [% × 1 [6] [% × 10 [7] [% × 100	0 7	0	

7-2

0	
1	0
2	1
3	2
4	3
5	4
6	[32]
7	[32]
8	32_MSW
9	32_LSW
10	
11	
12	0 @32bi t
13	1 @32bi t
14	2 @32bi t
15	3 @32bi t
16	4 @32bi t
17	5 @32bi t
18	[Hz]
19	[rpm]
20	[%]
21	[%]
22	[%]
23	[Hz]
24	
25	
26	1[%]
27	2[%]
28	
29	
30 37	SET_W12 19

7-3

0	
1	0
2	1
3	2
4	3
5	4
6	5
7	0 @32bi t
8	1 @32bi t
9	2 @32bi t
10	3 @32bi t
11	4 @32bi t
12	5 @32bi t
13	[32]
14	[32]
15	32bi t_MSW
16	32bi t_LSW
17	
18	
19	
20	[rpn]
21	[rpn]
22	
23	
24	
25	
26	
27	A
28	B

29	C
30	
31	
32	
33	1
34	2
35	
36	
37	
38	
39	
40	
41	MWh
42	KWh
43	MWh
44	KWh
45 48	AV26 29

2 [1]
 4 16 (8421)
 (FORWARD) (REVERSE) P12 2(1)

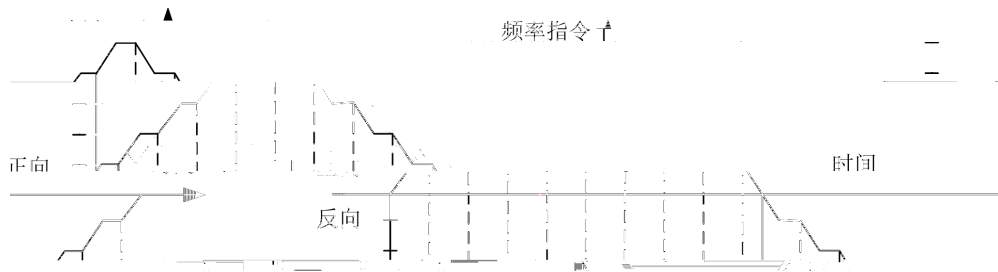

9.3

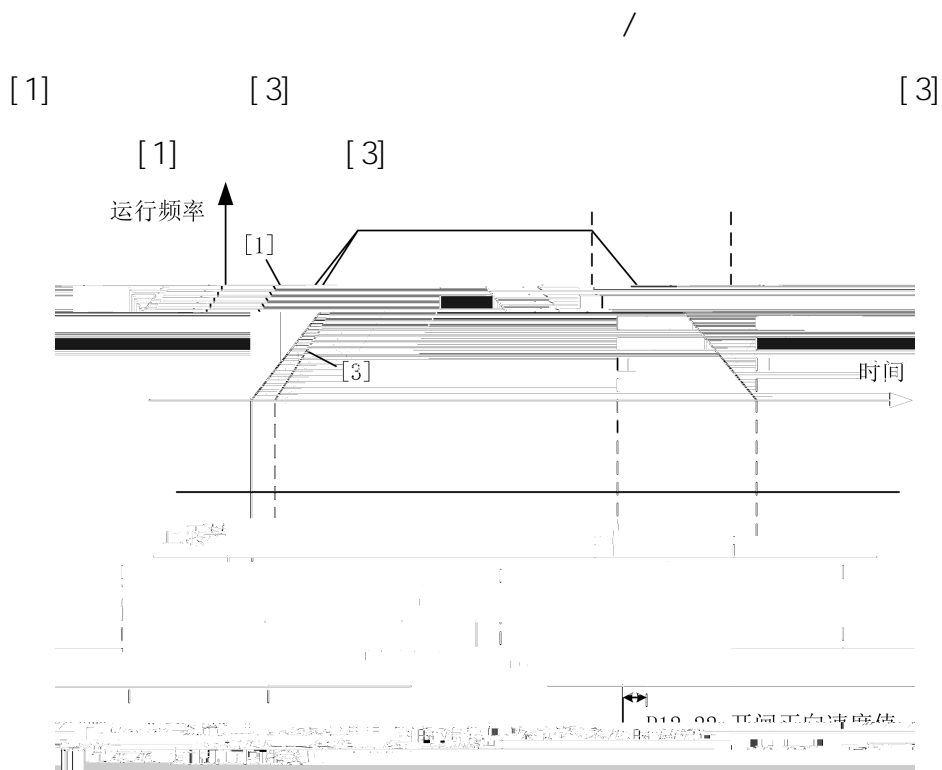

9.4

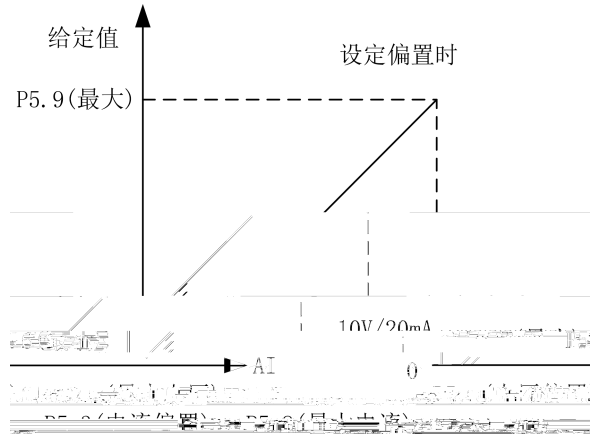
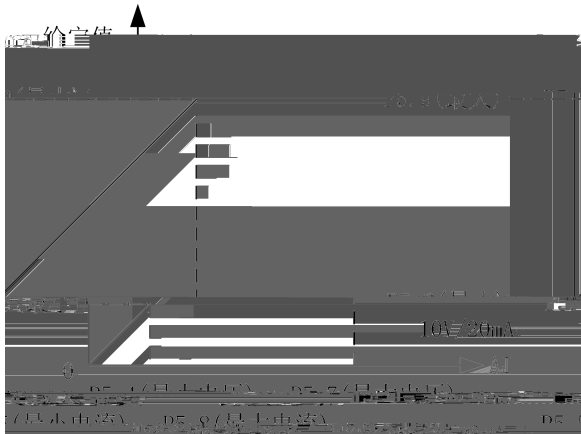

9.5

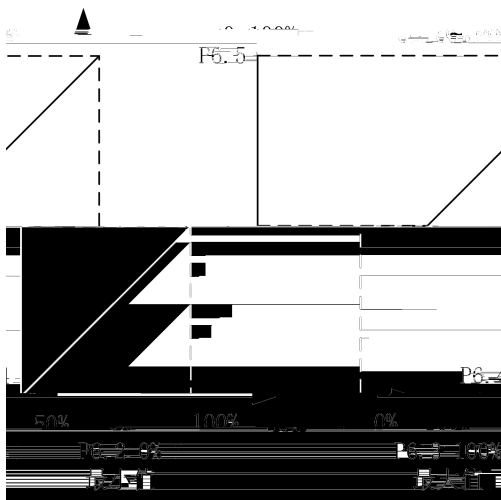

(a) 0~100%

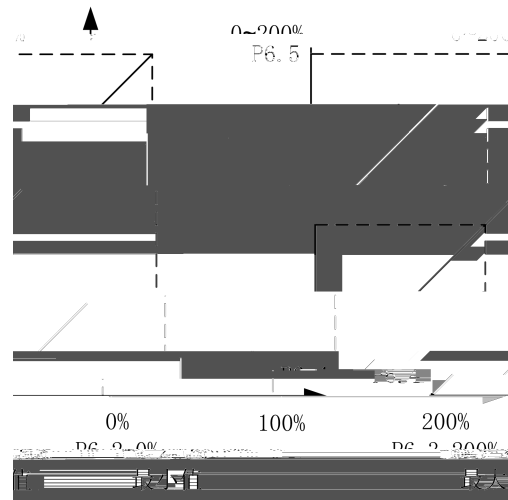

b 0~200%

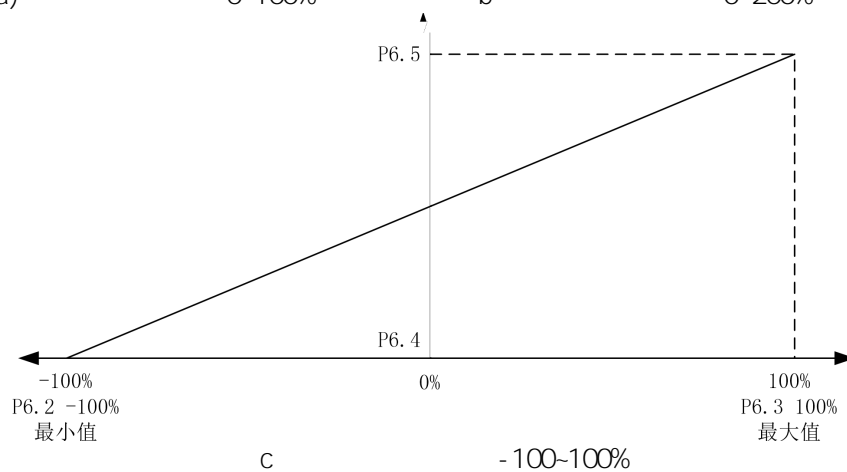

c -100~100%



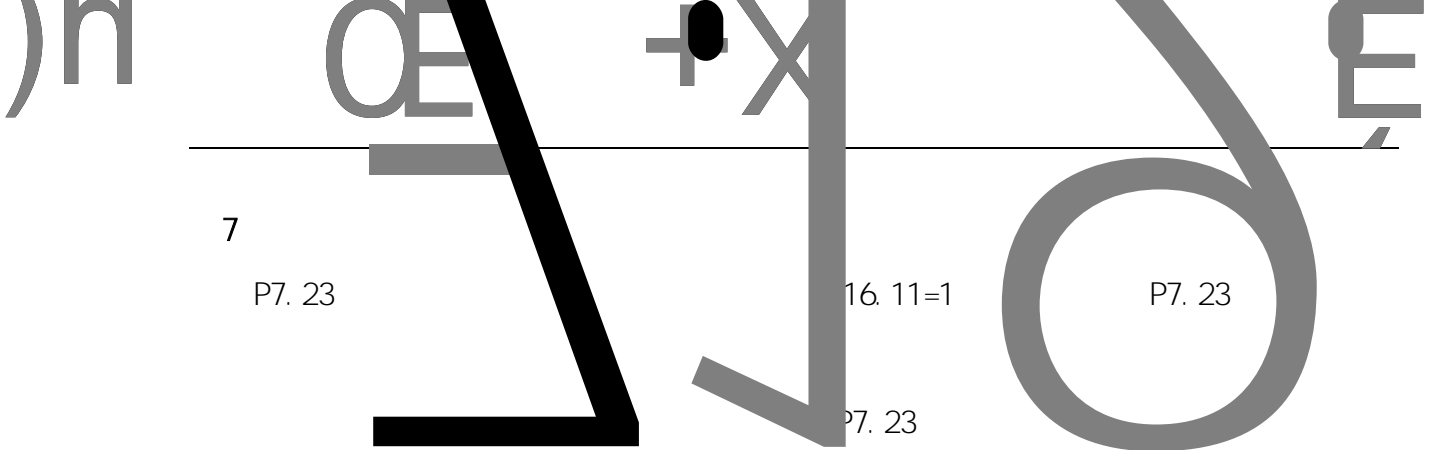

7

P7. 23

16. 11=1

P7. 23

P7. 23

P7. 24 P7. 26

P17. 11=1 P18. 11=1 P19. 11=1

. 8

P7. 31 P7. 32

P16. 11=2

P7. 31

100%

P7. 32

P7. 31

“

9.7

1

P8.3

[0]

[1]

P8.6

P8.6

P8.7

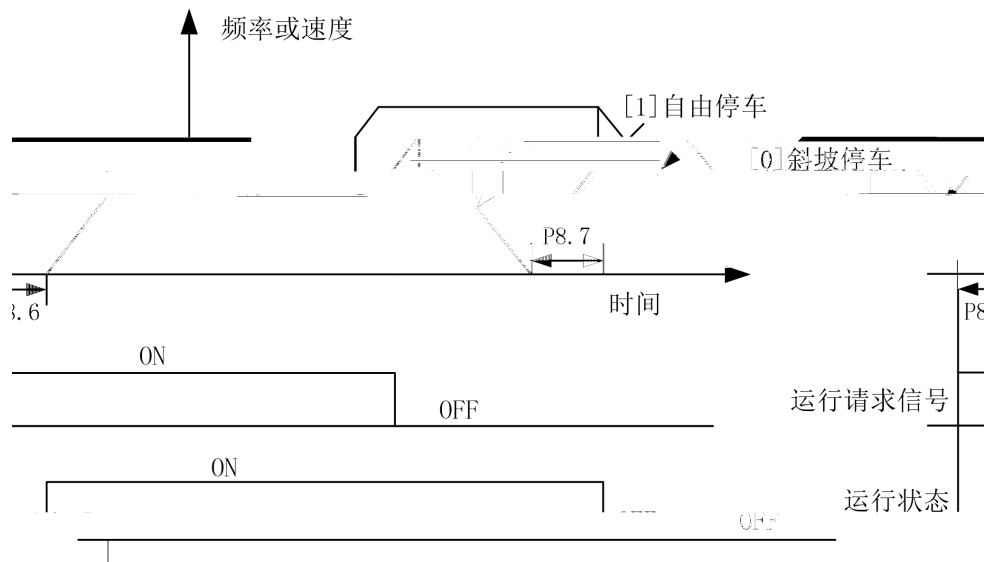

2

P8.14

P8.14

P8.33

P8.33

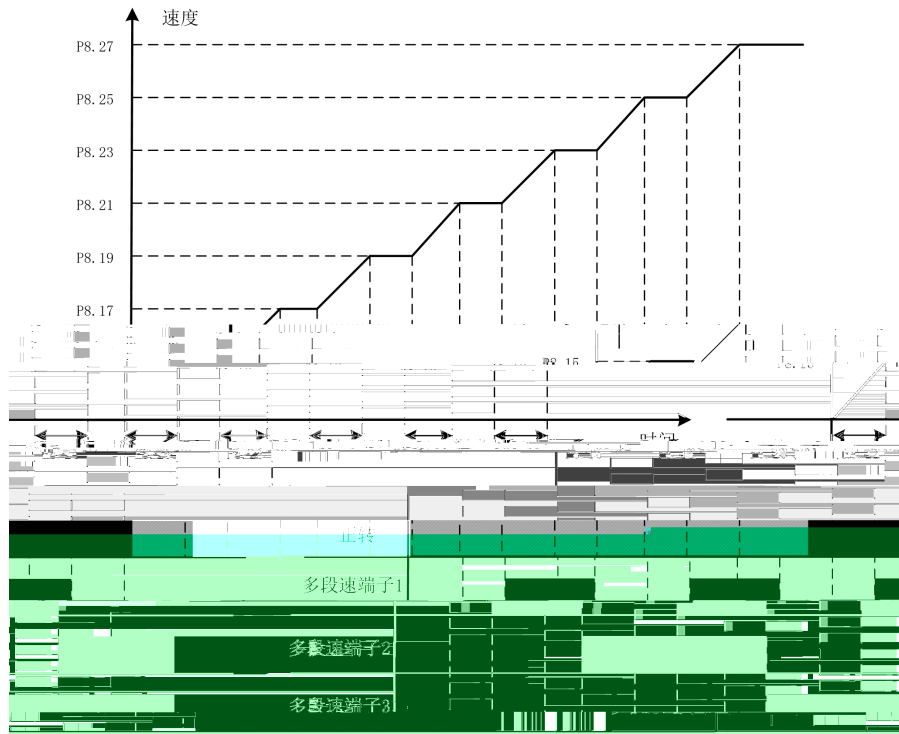

P8.15 < P8.17 < P8.19 < P8.21 < P8.23 < P8.25 < P8.27

P8.15	P8.17	P8.19	P8.21	P8.23	P8.25	P8.27
10%	20%	30%	50%	60%	80%	100%

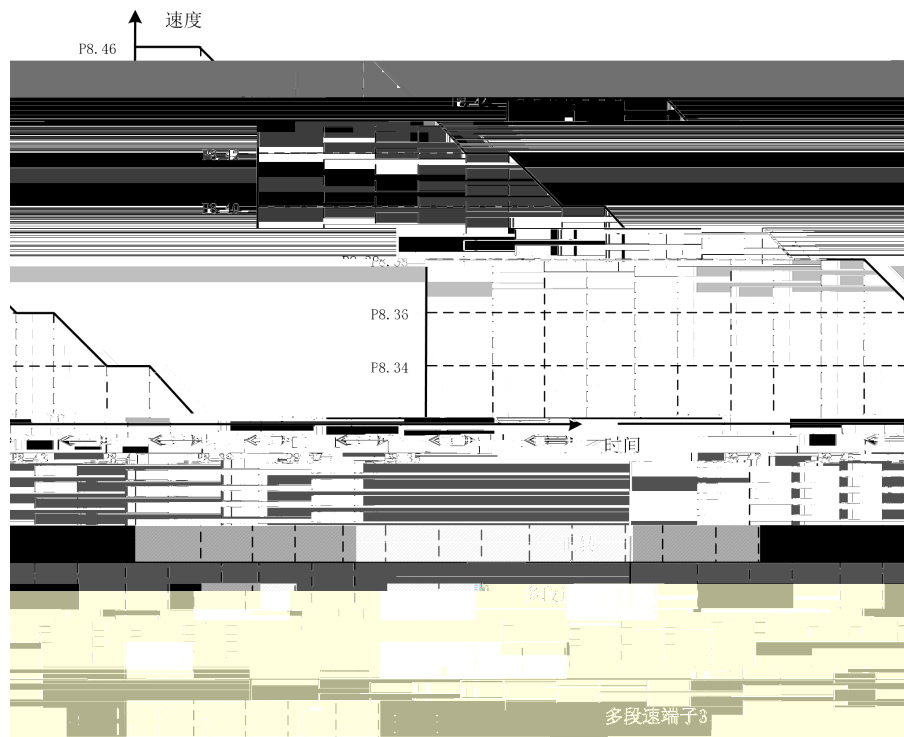

2

P12. 22 P12. 37

[3]

P12. 22 P12. 23

P12. 24 P12. 25

P12. 32[] P12. 33[]

P12. 28 P12. 29

P12. 36 P12. 37

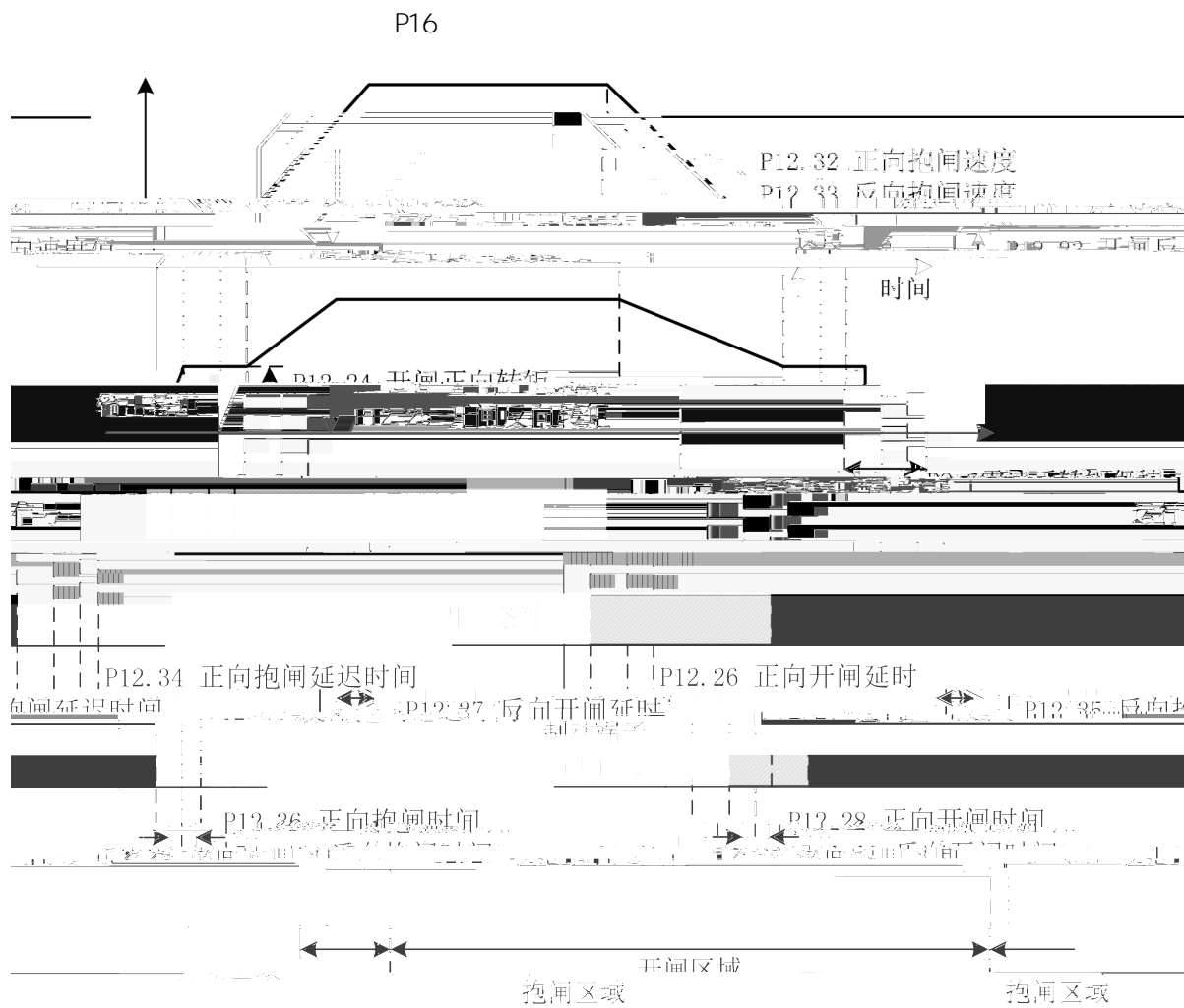

9.9

V/F

1

P16.0 P16.9

È

P16.7

120x P16.5/P16.6, P16.9

120x P16.5/P16.7

P16.2

P16.4 Ní#Ñ, 5l#UIG÷ Æ E-

2

P16.12

ĩ# È

• m'

[1] V/F

P16. 33 P16. 45

V/F

[2]

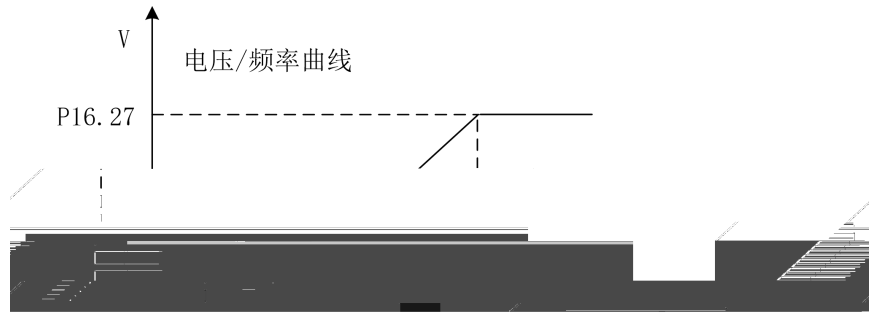

P16. 14=[2]

V/F

P16. 30 P16. 30

P16. 27

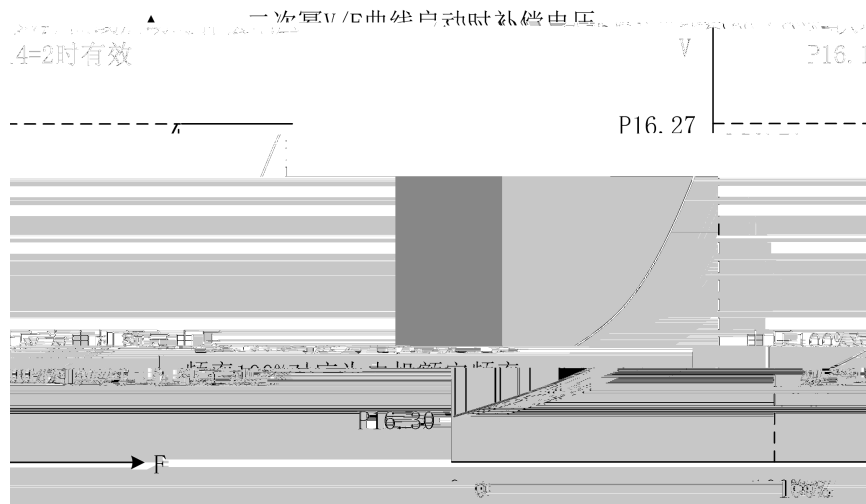

6

P16. 50 P16. 56

V/F

P16. 50 P16. 51 P16. 52

P16. 54 P16. 55 P16. 56

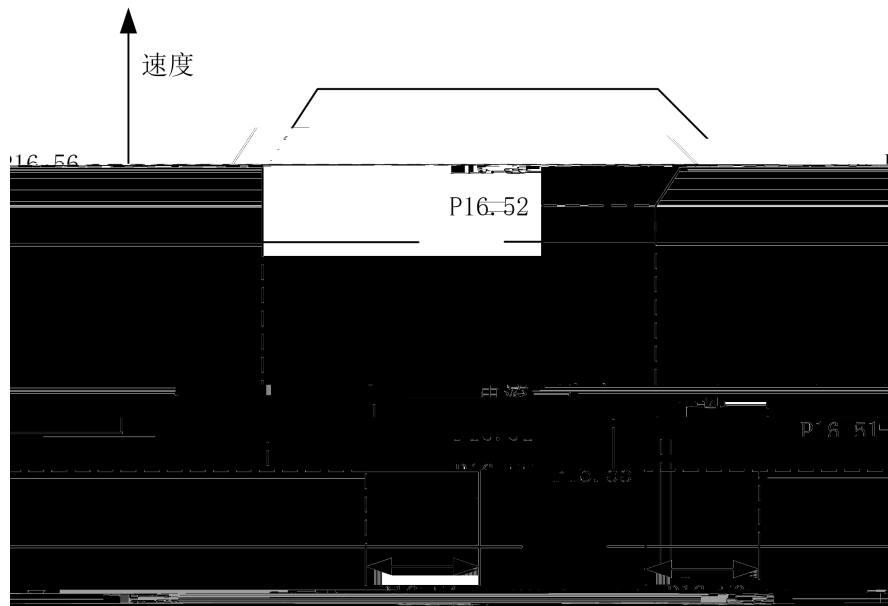

7

P16. 64

9. 10

1

P20. 0

P20. 0=0 P20. 1=0 P20. 2=0

P20. 0=0 P20. 1 0 P20. 2 0

P20. 0=1 P20. 1 0 P20. 2 0 1

0

P16. 11 [1] [2]

P20. 3 P20. 1 [4]

2

P20. 7

P20. 8 P20. 9 P20. 7=1

3

P20. 13

4

P20. 15

A B

A B

U V W

[0]

[1]

A B

5

GDHF - PGD1 PG

GDHF - PGD1 PG

DI " [10] " DP " CVD. 9 "

P20. 26 P20. 27 0

2%

P20. 34 [0] 1

0 P20. 26 P20. 27 0

P20. 26 50% 100% P20. 27 3% 5%

P20. 34 [1] 2

200 P20. 26 P20. 27 0

HF650LC

P20. 34 [1]

9.11

P16. 64
V/F (10 40Hz) 100 80 150

P16. 12

a

V/F

10.

10.1

V01	SYS_NOT_RDY	(Ready)			
			[P3	
V02	NO_DRV_ENABLE]			
			[P3	X
V03	LOCAL_EM]			
			[
V04	REMOTE_EM				



[E050]	U	ERR_UT not reset	I GBT		
			I GBT		
[E051]	U	ERR_UT not reset	I GBT		
			I GBT		
[E052]	V	ERR_UT not reset	I GBT		
			I GBT		
[E053]	V	ERR_UT not reset	I GBT		
			I GBT		
[E054]	W	ERR_UT not reset	I GBT		
			I GBT		
[E055]	W	ERR_UT not reset	I GBT		
			I GBT		
[E056]		ERR_SLAVE_FAULT not reset			
[E100]		OV	P8. 35(1)	
			P7. 12()	
[E105]		UVW	E	u	

[E112]

[E128]	IGBT8 OT8				
[E137]	FAN STALL				
[E138]	TEMP_SENSING FAIL				
[E139]	Pre_Charging Fail		P7.95		
[E140]	Line UV				
[E141]	Line OPEN				
[E142]	Line Detection Error				
[E143]	Line SW Fail	DI		o3	N N n

10.3

		•	• DC15V
		•	• D05 • D05 •
		•	• D04 •

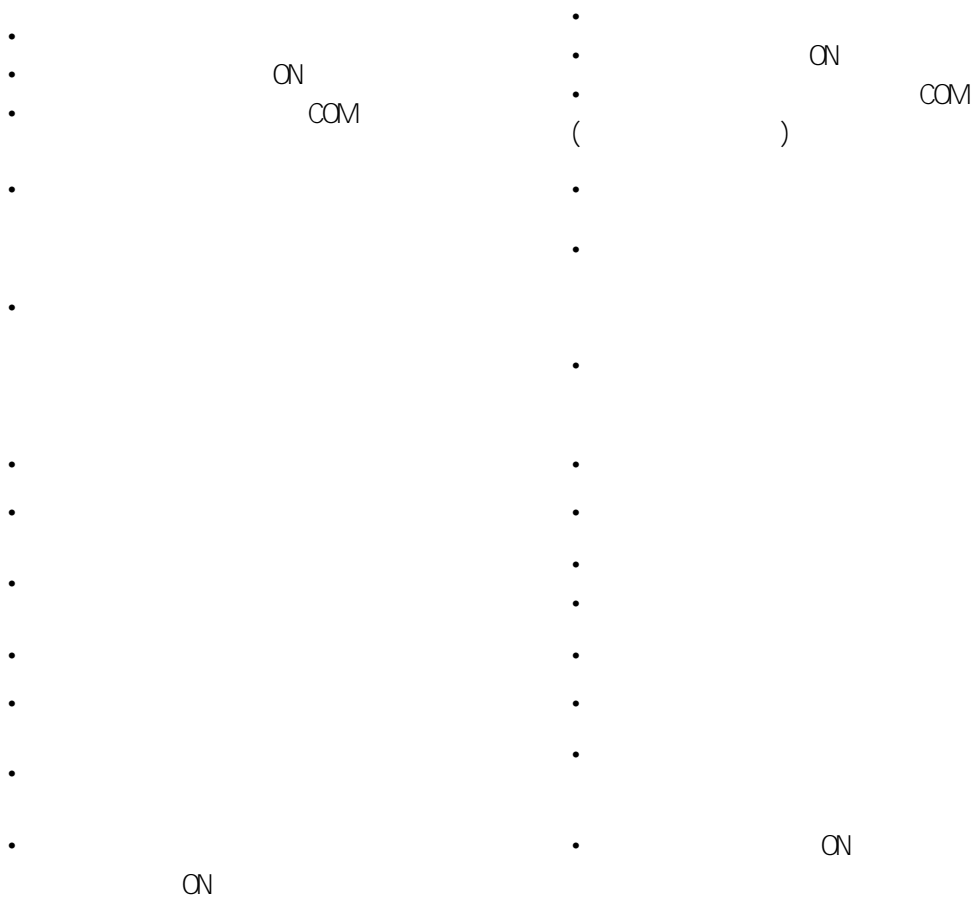

	•	•
	• • •	• • •
	•	•
	•	•
	•	•
	• ()	•
	•	•

11.

	
1	
2	
3	
4	
	
1	CMS
2	
3	

11. 1

11. 2

	1. 2	1. > 40 < 95% 2.
	1. 2 3.	1. 2 3. 4. 5. 6.
	1. 2 3.	1. 2 3.
	1. 2	1. 2.
	1. 2	1. 2

11. 3

		1
	2	2
PCB		

11. 4

